

# Direct Torque Control of Induction Motor Using Space Vector Modulation (SVM-DTC)

Emre Ozkop, Student Member, IEEE  
Dept. of Electrical and Electronics Engineering  
Karadeniz Technical University  
61080 Trabzon, Turkey  
eozkop@ktu.edu.tr

Halil I. Okumus, Member, IEEE  
Dept. of Electrical and Electronics Engineering  
Karadeniz Technical University  
61080 Trabzon, Turkey  
okumus@ktu.edu.tr

**Abstract-** In this study, direct torque control (DTC) of induction motor is evaluated based on space vector modulation (SVM). DTC is a method to control machine with utilizing torque and flux of motor controlled. The torque and current ripple are occurred in the conventional DTC. Reason of undesired torque and current ripple is low number of voltage vectors applied to the motor controlled by the conventional DTC technique. SVM-DTC is a technique to reduce the ripple. SVM techniques have several advantages that are offering better DC bus utilization, lower torque ripple, lower total harmonic distortion in the AC motor current, lower switching loss, and easier to implement in the digital systems. Simulation results from the classical and improved DTC are presented and compared. Result shows that the torque, flux linkage and stator current ripple are decreased with the improved DTC.

## I. INTRODUCTION

Induction Motors (IMs) are widely used in high-performance drives. Its history is very extensive and also control is important in applications. There are many IMs in a number of industrial, commercial and domestic applications of variable speed drives. Since IMs demands well control performances: precise and quick torque and flux response, large torque at low speed, wide speed range, the drive control system is the most sensitive point of IMs [1].

DTC is method to control machine with utilizing torque and flux of motor controlled. The basic DTC scheme consists of two comparators having different features, switching table, Voltage Source Inverter (VSI), flux and torque estimation block and IM.

Like a every control method has some advantages and disadvantages, DTC method has too. Some of the advantages are lower parameters dependency, making the system more robust and easier implements and the disadvantages are difficult to control flux and torque at low speed, current and torque distortion during the change of the sector in d-q plane, variable switching frequency, a high sampling frequency needed for digital implementation of hysteresis controllers, high torque ripple. The torque ripple generates noise and vibrations, causes errors in sensorless motor drives, and associated current ripples are in turn responsible for the EMI. The reason of the high current and torque ripple in DTC is the presence of hysteresis comparators together the limited number of available voltage vectors [2]. To reduce the torque

ripple, the stator flux vector change, which is demanded to compensate the torque and flux errors, determination should be done and also any voltage vector should be produced by the control mechanism. If a higher number of voltage vectors than those used in conventional DTC is used, the favorable motor control can be obtained. Because of complexity of power and control circuit, this approach is not satisfactory for low or medium power applications. One of the methods to increase the number of available vectors is an on-line modulation between active and null vectors [2].

In order to overcome the problem, the SVM-DTC and DSVM-DTC methodologies were proposed [3]. The basis of the SVM-DTC methodology is the calculation of the required voltage space vector to compensate the flux and torque errors exactly by using a predictive technique and then its generation using the SVM at each sample period [3]. There are different SVM techniques, which are Direct-Reverse SVM, Direct-Direct SVM, Direct-Direct with  $V_{null}=[000]$ , Direct-Direct with  $V_{null}=[111]$  in industry applications [4]. The choice of the SVM technique to be used will depend on the optimization criteria under consideration, whether it is the torque/current ripple, the harmonic losses or the switching losses.

## II. CONTROL METHOD

### A. Conventional DTC

DTC method has been first proposed for induction machines. DTC technique introduced by Takahashi and Noguchi [5] for low and medium power application and DTC technique introduced by Depenbrock [6] for high power application are popular in industry. DTC strategy is quite different from that of the field orientation control (FOC) or vector control, which does not need complicated coordination transformations and decoupling calculation [7]. The basic model of the conventional DTC induction motor scheme is shown in Figure 1. Two stator currents ( $i_{SA}$  and  $i_{SB}$ ) and DC-bus voltage VDC are sampled. d-q components of stator voltage and current space vectors in the stationary reference frame and also magnitude of the stator flux and electric torque are calculated as shown below [3].

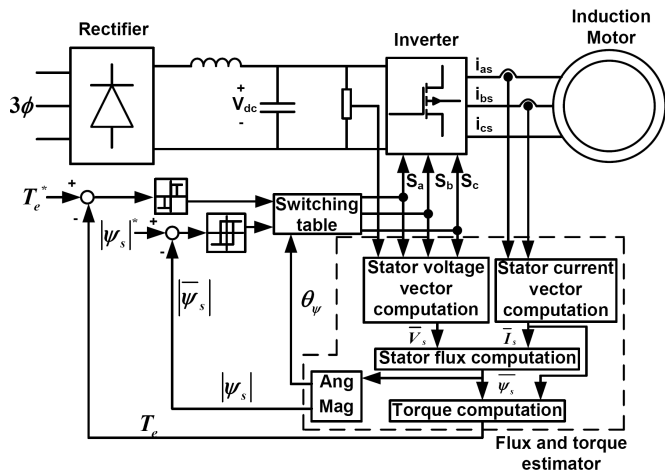

Figure 1. Basic DTC induction motor scheme.

$$V_{sd} = \frac{2}{3} V_{dc} (S_A - \frac{S_B + S_C}{2}) \quad (1)$$

$$V_{sq} = \frac{1}{\sqrt{3}} V_{dc} (S_A - S_C) \quad (2)$$

$$i_{sd} = i_{SA} \quad (3)$$

$$i_{sq} = \frac{i_{SA} + 2i_{SB}}{\sqrt{3}} \quad (4)$$

$$|\psi_s| = \sqrt{\psi_{sd}^2 + \psi_{sq}^2} \quad (5)$$

$$T_e = \frac{3}{2} P (\psi_{sd} i_{sq} - \psi_{sq} i_{sd}) \quad (6)$$

$$\psi_{sd} = \int (V_{sd} - R_s i_{sd}) dt \quad (7)$$

$$\psi_{sq} = \int (V_{sq} - R_s i_{sq}) dt \quad (8)$$

The magnitude of stator flux and electric torque calculated are compared with their reference values in the hysteresis comparators shown in Figure 2 and then the outputs of the comparators are fed to a switching table to select an appropriate inverter voltage vector. The switching table shown as Table I determine the voltage vector to apply based on the position of the stator flux and the required changes in stator flux magnitude and torque [8]. The selected voltage vector will be applied to the induction motor at the end of the sample time. In VSI, there are six equally spaced voltage vectors having the same amplitude and two zero voltage vectors. VSI voltage vectors are shown in Figure 3.

In DTC, torque and flux are controlled independently by selecting the optimum voltage space vector for entire switching period and the errors are maintained with in the hysteresis band [9]. In conventional DTC, only one vector is applied for the entire sampling period. So for small errors, the motor torque may exceed the upper/lower torque limit. Instead by using more than one vector with in the sampling period

torque ripple can be reduced. The slip frequency can be controlled precisely by inserting zero vectors [10]. For the small the hysteresis band, frequency of operation of PWM inverter could be very high. The switching frequency always varies according to the width of hysteresis band.

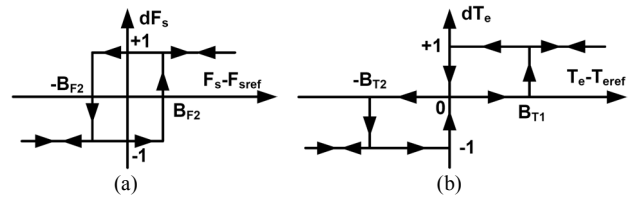

Figure 2. Hysteresis comparator (a) Stator flux (b) Torque.

TABLE I. Switching Table

Flux error position	Torque error position	Sector I	Sector II	Sector III	Sector IV	Sector V	Sector VI
1	1	V2(110)	V3(010)	V4(011)	V5(001)	V6(101)	V1(100)
	0	V7(111)	V0(000)	V7(111)	V0(000)	V7(111)	V0(000)
	-1	V6(101)	V1(100)	V2(110)	V3(010)	V4(011)	V5(001)
0	1	V3(010)	V4(011)	V5(001)	V6(101)	V1(100)	V2(110)
	0	V0(000)	V7(111)	V0(000)	V7(111)	V0(000)	V7(111)
	-1	V5(001)	V6(101)	V1(100)	V2(110)	V3(010)	V4(011)

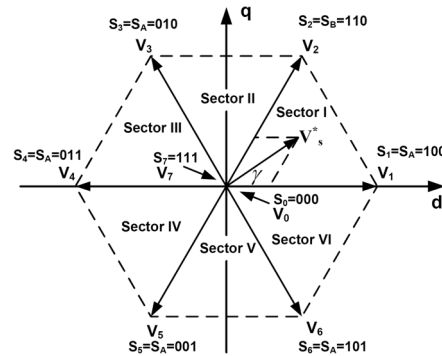

Figure 3. VSI voltage vectors.

### B. Space Vector Modulation

Common disadvantages of conventional DTC are high torque ripple and slow transient response to the step changes in torque during start-up. Several techniques have been developed to improve the torque performance. One of them is to reduce the ripples is based on SVM technique [11].

SVM was first presented by a group of German researched in the second half of the 1980s. Since then, a lot of work has been done on the theory and implementation of SVM techniques. SVM techniques have several advantages that are offering better DC bus utilization, lower torque ripple, lower Total Harmonic Distortion (THD) in the AC motor current, lower switching losses, and easier to implement in the digital systems. At each cycle period, a preview technique is used to obtain the voltage space vector required to exactly compensate the flux and torque errors. The torque ripple for this SVM-DTC is significantly improved and switching frequency is maintained constant [11]. SVM, based on the switching between two adjacent boundary active vectors and a zero

vector during one switching period,  $T_z$ , and for a given reference voltage vector in the first sector ( $0-60^\circ$ ) is shown in Figure 4(a).

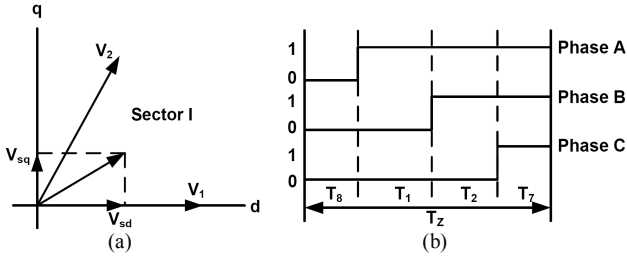

Figure 4. SVM in the first sector (a) reference voltage vector (b) switching pattern for three-phase modulation.

The switching times can be calculated using the following equations [12].

$$\vec{V}_s^* = V_{sd} + jV_{sq} \quad (9)$$

where the vectors  $V_{sd}$  and  $V_{sq}$  are obtained from the appropriate voltage vectors for any given sector.

$$T_z \vec{V}_s^* = T_A \vec{V}_1 + T_B \vec{V}_2 \quad (10)$$

$$\begin{aligned} & T_A \sqrt{\frac{2}{3}} V_{dc} \begin{bmatrix} \cos 0^\circ \\ \sin 0^\circ \end{bmatrix} + T_B \sqrt{\frac{2}{3}} V_{dc} \begin{bmatrix} \cos(\pi/3) \\ \sin(\pi/3) \end{bmatrix} \\ &= T_z \sqrt{\frac{2}{3}} V_{dc} a \begin{bmatrix} \cos \gamma \\ \sin \gamma \end{bmatrix} \end{aligned} \quad (11)$$

$$T_A = T_z a \frac{\sin(\pi/3 - \gamma)}{\sin(\pi/3)} \quad (12)$$

$$T_B = T_z a \frac{\sin(\gamma)}{\sin(\pi/3)} \quad (13)$$

$$T_0 = T_7 = T_z - T_B - T_A \quad (14)$$

$$0 \leq \gamma \leq \pi/3, a = \frac{|\vec{V}_s^*|}{\sqrt{\frac{2}{3}} V_{dc}}$$

The reference vector  $V_s^*$ , a constant magnitude and frequency in the steady-state, is sampled at equal time intervals of  $T_z$ . Within this sample time, the inverter is switched and made to remain at different switching states for different durations of time such that the average space vector generated within sample period is equal to the sampled value of the reference vector, both in terms of magnitude and angle [12, 13].

The switching states that can be used within  $T_z$  are the two zero states and the active states which are  $S_A$  and  $S_B$ , with vectors  $V_1$  and  $V_2$  respectively forming the start and the end boundaries of the sector as shown in Figure 4. The two

switching states ( $S_A$  and  $S_B$ ) are named active switching states.  $S_A$  indicates the inverter switching states (001), (100), or (010) and  $S_B$  indicates the inverter switching states (101), (110) or (011). Active vector times,  $T_A$  and  $T_B$ , are defined as the times due to the active switching states,  $S_A$  and  $S_B$  respectively. Null vector times  $T_0$  and  $T_7$  are defined as the times due to the null switching states  $S_0$ , (000), and  $S_7$ , (111) respectively. In DTC, with the space vector PWM technique, the DTC transient performance and robustness are preserved and the steady state torque ripple is reduced. Moreover, the inverter switching frequency is constant and totally controllable [14].

### III. SIMULATION RESULTS

Two Matlab models were developed to examine the different control algorithm. One is used for the conventional DTC and the other for the modified DTC. The parameters of the induction motor are shown in Table II.

TABLE II. Parameters of the induction motor used

Stator resistance $R_s$	3 $\Omega$
Rotor resistance $R_r$	5.6 $\Omega$
Rotor Inductance $L_r$	0.0154 H
Mutual inductance $M$	0.0102 H
Stator Inductance $L_s$	0.0154 H
Phase voltage $V$	250 V
Base speed $\omega_b$	314 rad/s
Inertia $J$	0.002 $\text{kgm}^2$
Frequency $f$	50 Hz

The steady state behavior of induction motor with the conventional DTC and SVM-DTC are illustrated in Figure 5-12. Figure 5 and 6 show a comparison of stator flux space vector obtained using two control methods. As it is possible to see in Figure 7-12 an appreciable reduction of current, flux and torque ripple has been obtained using the SVM-DTC technique.

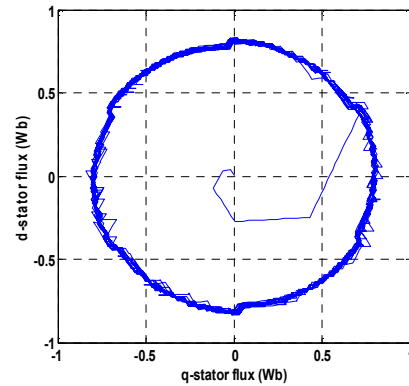

Figure 5. d-q stator flux with conventional DTC scheme

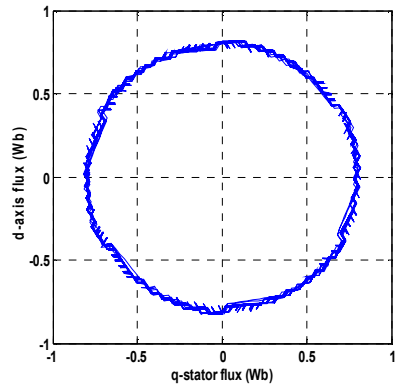

Figure 6. d-q stator flux with SVM-DTC scheme.

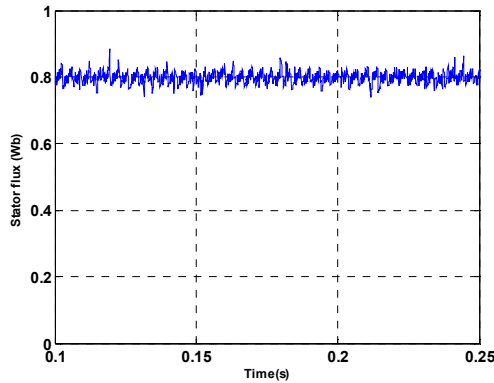

Figure 7. Stator flux magnitude with conventional DTC scheme.

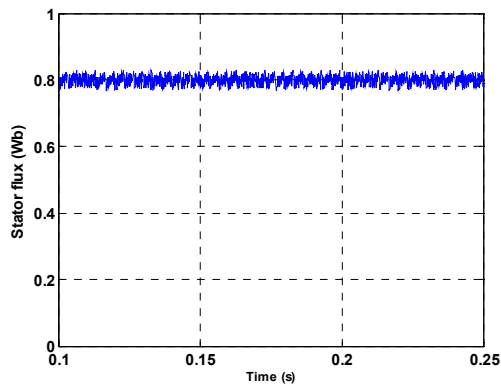

Figure 8. Stator flux magnitude with SVM-DTC scheme.

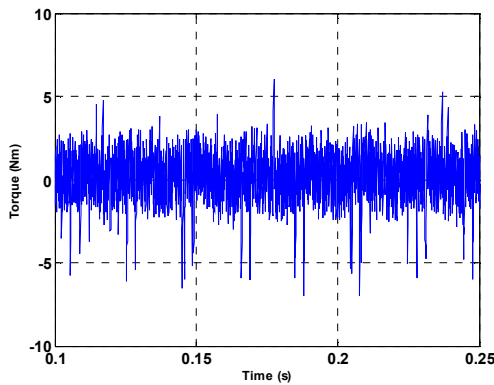

Figure 9. Output torque with conventional DTC scheme.

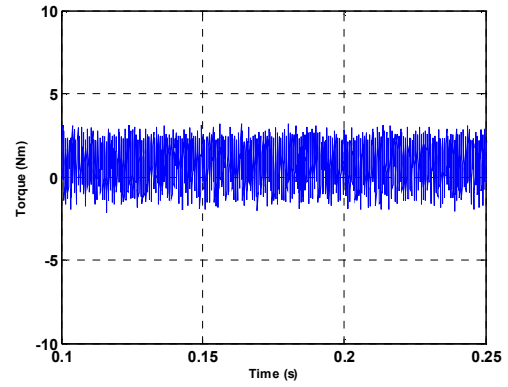

Figure 10. Output torque with SVM-DTC scheme.

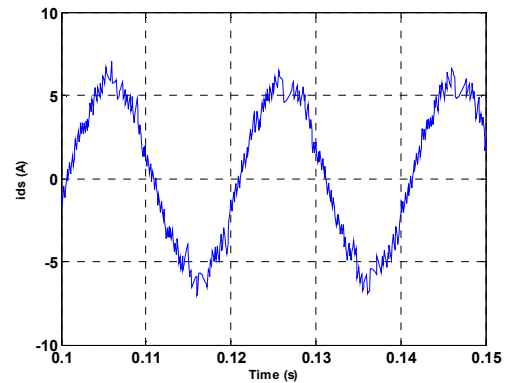

Figure 11. Stator d-current with conventional DTC scheme.

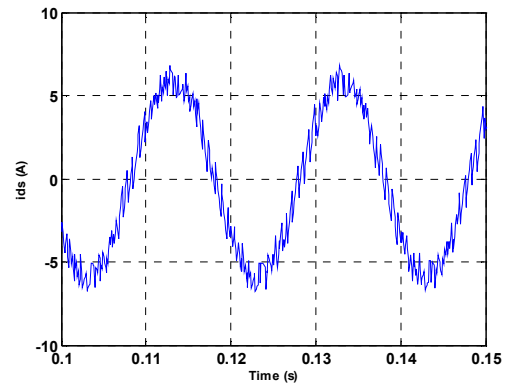

Figure 12. Stator d-current with SVM-DTC scheme.

#### IV. CONCLUSION

In classical DTC, as the torque ripple is maintained within hysteresis band, switching frequency changes with speed. Moreover, the torque ripple is important problem at low speed. So using constant switching frequency a desired torque ripple can be achieved at low speeds where it really matters. The torque ripple for this SVM-DTC is significantly improved and switching frequency is maintained constant. Numerical simulations have been carried out showing the advantages of the SVM-DTC method with respect to the conventional DTC.

## REFERENCES

- [1] S. Jianguo and C. Quanshi, "Research of electric vehicle IM controller based on space vector modulation direct torque control," *Proceedings of the Eighth International Conference on Electrical Machines and Systems, ICEMS 2005*, vol. 2, pp. 1617-1620, 2005.
- [2] D. Ocean, L. Romeral, J.A. Ortega, J. Cusido, and A. Garcia, "Discrete space vector modulation applied on a PMSM motor," *12<sup>th</sup> International Power Electronics and Motion Control Conference, EPE-PEMC 2006*, pp. 320-325, 2006.
- [3] H.R. Keyhani, M.R. Zolghadri, and A. Homaifar, "An extended and improved discrete space vector modulation direct torque control for induction motors," *35<sup>th</sup> Annual IEEE Power Electronics Specialists Conference*, Germany, pp. 3414-3420, 2004.
- [4] R.H. Ahmad, G.G. Karady, T.D. Blake, and P. Pinewski, "Comparison of space vector modulation techniques based on performance indexes and hardware implementation," *23<sup>rd</sup> International Conference on Industrial Electronics, Control and Instrumentation, IECON 97*, vol. 2, pp. 682-687, 1997.
- [5] I. Takashi and T. Noguchi, "A new quick-response and high-efficiency control of an induction motor," *IEEE Trans. Industry Applications*, vol. IA-22, no.5, pp. 820-827, 1986.
- [6] M. Depenbrock, "Direct self control (DSC) of inverter-fed induction machines," *IEEE Trans. Power Electronics*, vol. 3, no. 4, pp. 420-429, 1988.
- [7] M. Jin, J. Qiu, C. Shi, and R. Lin, "A fuzzy DTC method with a SVM defuzzification to permanent magnet synchronous machine," *The 30<sup>th</sup> Annual Conference of the IEEE Industrial Electronics Society, Korea*, pp. 3196-3199, 2004.
- [8] M. Vasudevan and R. Arumugam, "New direct torque control scheme of induction motor for electric vehicles," *5<sup>th</sup> Asian Control Conference*, pp. 1377-1383, 2004.
- [9] A. Kumar, B.G. Fernandes, and K. Chatterjee, "Simplified SVPWM-DTC of 3-phase induction motor using the concept of imaginary switching times," *The 30<sup>th</sup> Annual Conference of the IEEE Industrial Electronics Society, Korea*, pp. 341-346, 2004.
- [10] U. Senthil and B.G. Fernandes, "Hybrid space vector pulse width modulation based direct torque controlled induction motor drive," *IEEE 34<sup>th</sup> Annual Power Electronics Specialist Conference, PESC'02*, vol. 3, pp. 1112-1117, 2003.
- [11] L. Chen, K.L. Fang, and Z.F. Hu, "A scheme of fuzzy direct torque control for induction machine," *Proceedings of the Fourth International Conference on Machine Learning and Cybernetics, Guangzhou*, pp. 803-807, 2005.
- [12] H.I. Okumus, "Improved direct torque control of induction machine drives," *PhD Thesis, University of Bristol, UK*, July 2001.
- [13] L. Tang, M.F. Rahman, "A new direct torque control strategy for flux and torque ripple reduction for induction motors drive by using space vector modulation," *IEEE 32<sup>nd</sup> Annual Power Electronics Specialists Conference, PESC 2001*, vol. 3, pp. 1440-1445, 2001.
- [14] D. Swierczynski, M.P. Kazmierkowski, and F. Blaabjerg, "DSP based direct torque control of permanent magnet synchronous motor (PMSM) using space vector modulation (DTC-SVM)," *Proceedings of the 2002 IEEE International Symposium on Industrial Electronics, ISIE 2002*, vol. 3, pp. 723-727, 2002.