

On the Synchronous Generator Parameters Determination Using Dynamic Simulations Based on IEEE Standards

J.C. Pequeira, E. Ruppert and M.T. Mendoza

School of Electrical and Computer Engineering - UNICAMP

jcarlosp@dsce.fee.unicamp.br, ruppert@fee.unicamp.br, mmendoza@dsce.fee.unicamp.br

Abstract-This paper shows, through simulations using the software Matlab/Simulink and its library Simpowersystems, how to perform the synchronous generator load rejection tests and how to obtain the values of the synchronous generator electrical operational parameters which are important data to perform generator and electrical power system dynamic studies. The paper discuss the d -axis load rejection test, the q -axis load rejection test, the arbitrary axis load rejection test also shows how to calculate the electrical fundamental parameters which characterizes the synchronous generator.

I. INTRODUCTION

The synchronous generators are responsible for almost all electrical energy generated in the world today. In the studies of dynamics and control of electrical energy systems the dynamic mathematical modeling of the synchronous generators assumes a role of relevant importance so that this matter has been studied since the first large-scale electricity generation system in the world until now with high intensity.

Many papers have been written since the first one [1] until our days [2] about the synchronous generators definition, characterization and measurement of electrical parameters so that many test procedures for determining parameters were developed in such way that the IEEE, IEC and NEMA which are important standardization societies of the U.S.A and Europe on electricity subjects had considered necessary their standardization, as it can be seen in the standards [3], [4] and [5].

The synchronous generator fundamental electrical parameters are: the per phase stator windings electrical resistance (r_s), the field winding (r_{fd}), the d and q -axis damping winding electrical resistances (r_{kd} and r_{kq}), the per phase stator windings leakage reactance (x_{ls}), the field winding leakage reactance (x_{lf}), the d and q -axis damping winding leakage reactances (x_{lkd} and x_{lkq}) and also the d and q -axis generator magnetizing reactances (x_{md} and x_{mq}), however those parameters can be determined just only if the standard parameters are determined. The standard parameters of the synchronous generators are the d and q -axis synchronous reactances (x_d and x_q), the d and q -axis transient synchronous reactances (x'_d and x'_q), the d and q -axis sub-transient synchronous reactances (x''_d and x''_q), the d and q -

axis open-circuit transient and sub-transient time constants (T'_{do} , T'_{qo} , T''_{do} and T''_{qo}) and the d and q -axis short-circuit transient and sub-transient time constants (T'_d , T'_q , T''_d and T''_q).

The synchronous generator standard parameters can be determined through load rejection tests, among other methods, while the fundamental parameters are calculated using mathematical relations as shown in [6], [7] and presented in the appendix A.

This paper shows how the standard parameters can be determined by the load rejection tests through simulations performed by using the software Matlab-Simulink-SimPowerSystems showing important details of how to calculate those parameters. Results of simulation of the load rejection tests at rated voltage are presented for a hydrogenerator (salient pole synchronous generator) whose data are shown in the appendix B which has one field winding, one d -axis damping winding and one q -axis damping winding.

Round rotor synchronous generators (turbogenerators) must be represented by a mathematical model with more than one q -axis damping windings due to the solid iron rotor and the associate Skin Effect. Usually it uses one d -axis and two q -axis damping winding [6], [7].

II. SYNCHRONOUS GENERATOR DYNAMIC MATHEMATICAL MODEL

The dynamic mathematical model of a synchronous generator with two q -axis damping winding utilized in the block called "synchronous machine" of the SimPowerSystems library of the software Matlab/Simulink, is composed by the set of differential equations as presented in [7] and also bellow (1). This library allows to the user to include the magnetic saturation model. In the simulations performed in this work the magnetic saturation effects are not taken into account.

The electrical differential equations that describe the stator and the rotor windings are shown in (1) and are written in dq axis coordinate system which rotates at the rotor speed. The first three equations represent the stator windings (subscript s) and the following four equations represent the rotor windings.

The subscript f is used for the field winding while the subscript k is used for the damping windings (kd for the direct axis damping winding and $kq1$ for the q -axis, number 1 damping winding and $kq2$ for the q -axis, number 2, damping winding). In the machine used as example in this work there is just one damping winding in the q -axis, designated as $kq2$ as in [7].

$$\begin{aligned}
v_{qs}^r &= -r_s^r i_{qs}^r + \frac{\omega_r}{\omega_b} \psi_{ds}^r + \frac{p}{\omega_b} \psi_{qs}^r \\
v_{kq2}^r &= r_{kq2}^r i_{kq2}^r + \frac{p}{\omega_b} \psi_{kq2}^r \\
v_{ds}^r &= -r_s^r i_{ds}^r - \frac{\omega_r}{\omega_b} \psi_{qs}^r + \frac{p}{\omega_b} \psi_{ds}^r \\
v_{fd}^r &= r_{fd}^r i_{fd}^r + \frac{p}{\omega_b} \psi_{fd}^r \\
v_{0s} &= -r_s^r i_{0s} + \frac{p}{\omega_b} \psi_{0s} \\
v_{kd}^r &= r_{kd}^r i_{kd}^r + \frac{p}{\omega_b} \psi_{kd}^r \\
v_{kq1}^r &= r_{kq1}^r i_{kq1}^r + \frac{p}{\omega_b} \psi_{kq1}^r
\end{aligned} \tag{1}$$

In these equations v represents the voltage of the several windings, i represents the electrical current circulating in the windings, Ψ represents the magnetic flux linking the windings, measured in *volts/s*, p is the differential operator (d/dt), ω_r is the angular speed of the rotor in *rad/s* referred to a two pole machine and ω_b is the reference angular speed (in this case is the synchronous angular speed corresponding to the rated frequency). The magnetic flux Ψ for each winding can be written as in (2). In this case v_{kd}^r , v_{kq1}^r , v_{kq2}^r are nulls because the damping windings are short-circuited.

$$\begin{aligned}
\psi_{qs}^r &= -x_{ls}^r i_{qs}^r + x_{mq} (-i_{qs}^r + i_{kq1}^r + i_{kq2}^r) \\
\psi_{ds}^r &= -x_{ls}^r i_{ds}^r + x_{md} (-i_{ds}^r + i_{fd}^r + i_{kd}^r) \\
\psi_{0s} &= -x_{ls}^r i_{0s} \\
\psi_{kq1}^r &= x_{lkq1}^r i_{kq1}^r + x_{mq} (-i_{qs}^r + i_{kq1}^r + i_{kq2}^r) \\
\psi_{kq2}^r &= x_{lkq2}^r i_{kq2}^r + x_{mq} (-i_{qs}^r + i_{kq1}^r + i_{kq2}^r) \\
\psi_{fd}^r &= x_{lfd}^r i_{fd}^r + x_{md} (-i_{ds}^r + i_{fd}^r + i_{kd}^r) \\
\psi_{kd}^r &= x_{lkd}^r i_{kd}^r + x_{md} (-i_{ds}^r + i_{fd}^r + i_{kd}^r)
\end{aligned} \tag{2}$$

The electrical fundamental parameters of the synchronous generator were already defined and they are: r_s , r_{fd} , r_{kd} , r_{kq1} , r_{kq2} , x_{ls} , x_{lf} , x_{lkd} , x_{lkq1} , x_{lkq2} , x_{md} and x_{mq} . The direct-axis reactance (x_d) and the quadrature axis reactance (x_q) are given by (3).

$$\begin{aligned}
x_d &= x_{ls} + x_{md} \\
x_q &= x_{ls} + x_{mq}
\end{aligned} \tag{3}$$

The mechanical part of the machine is described by two differential equations as shown in (4):

$$\begin{aligned}
p\delta &= \omega_r - \omega_s \\
\frac{2H}{\omega_s} p\omega_r &= T_m - (\psi_d i_{qs} - \psi_q i_{ds}) - T_{dam}
\end{aligned} \tag{4}$$

In these equations H is the turbine-generator set inertia constant, T_m is the mechanical torque of the turbine and T_{dam} is a damping torque that represents, among others, the rotational losses of the rotating parts. Inside the rotational losses are the magnetic losses and the mechanical losses (windage and friction losses).

III. SIMULATION SCHEME FOR THE SYNCHRONOUS GENERATOR OPERATION

Fig. 1 shows the SimPowerSystems simulation diagram used in this work to perform the load rejection tests. The infinite bus block put at the generator terminals is used to maintain the generator terminal voltage fixed and constant during the simulation at a chosen value (in this case the rated voltage). The real power is defined by the input P_m which is the mechanical input power and the reactive power is adjusted by the field voltage v_f .

IV. SOME SYNCHRONOUS GENERATOR LOAD REJECTION TESTS AT RATED VOLTAGE

The load rejection tests aims to the determination of the synchronous d and q -axis permanent, transient and sub-transient reactances and also the open circuit transient and sub-transient d and q -axis time constants. There are three types of load rejection tests: 1) the “ d -axis load rejection test” which permits to determine only x_d , x'_d , x''_d , T'_{do} and T''_{do} , 2) the “ q -axis load rejection test” which permits to determine only x_q and x''_q and 3) the “arbitrary axis load rejection test” which permits to determine only x_q , x'_q , x''_q , T'_{qo} and T''_{qo} . The parameters are determined from the envelope of the armature terminal voltage after de load rejection.

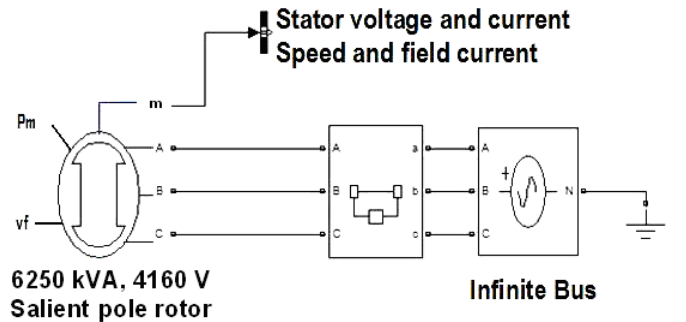

Fig. 1. Simpowersystems block diagram for generator load rejection test.

To perform the load rejection test the load must be switch off at the same time as the turbine is tripped, the excitation system must be in manual position and the voltage of the field winding must be maintained constant during the load rejection test. The short-circuit time constants can be calculated using the equations (A-1) and (A-3) shown in the appendix A.

To perform the “*d*-axis load rejection test” it is necessary to have the generator connected to the electrical power system supplying zero active power and supplying or drawing reactive power and the field current must be adjusted. In this case the armature current and also the armature magnetic flux is aligned with the *d*-axis. The terminal phase voltages are acquired and its arithmetic average is calculated and plotted to allow the calculation of the reactances x_d , x'_d and x''_d . The field current is also acquired to allow the calculation of the time constants T'_{do} and T''_{do} as it will be shown later. To perform the “*q*-axis load rejection test” it is necessary to have the generator connected to the electrical power system and the armature current having only the *q* component so the reactive power and the field current must be adjusted so that the power factor angle (φ) be equal to the power angle (δ). It it a test that requires a load angle measurement and so it is necessary to have an encoder installed in the generator shaft. The terminal phase voltages are acquired and its arithmetic average are calculated and plotted to allow the calculation of the reactances x_q and x''_q . This test in not so efficient because it permits only the determination of x_q and x''_q . Those values can be determined also by the arbitrary axis load rejection test.

To perform the “arbitrary axis load rejection test” the synchronous machine is suddenly disconnected from the electrical system while the armature current has any value (both *d* and *q*-axis components). The load angle δ need to be monitored because it is necessary to have the *d*-axis armature voltage curve and the *q*-axis armature current at the load rejection instant ($v_f \sin \delta$, and i_q) as in [8].

V. SIMULATION RESULTS

The proposed methods were applied to the salient pole synchronous generator shown in the appendix B.

A. *d*-axis load rejection test

To determine *d*-axis operational parameters the generator must be supplying zero active power and maximum possible reactive power [4]. To implement this condition in the simulation it is necessary to enter a zero mechanical power as input data, that is $P_m = 0$ (zero active power) and a determined field voltage to which the machine provides the maximum possible reactive power in a tentative and error process. In the studied case the conditions at the time immediately before the load rejection with the under excited machine are: $P_o = 0 pu$, $Q_o = 0.1239 pu$ (capacitive load), $V_{t_o} = 1 pu$, $i_{t_o} = 0.1239 pu$, $v_f = 0.87 pu$.

The dynamic of the generator terminal voltage can be seen in Fig. 2 where the load is rejected at time $t = 25 s$. For the calculation of operational reactances it is necessary to get the

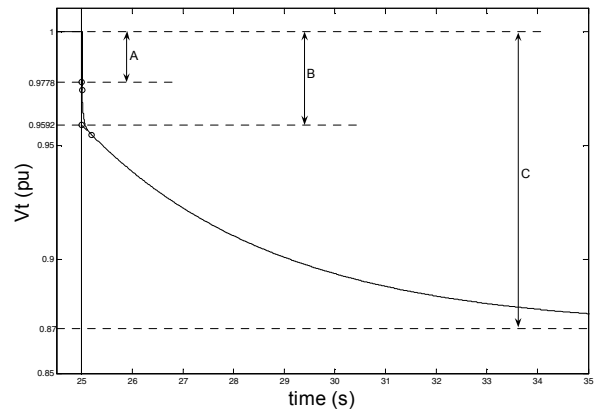

Fig. 2. Terminal voltage envelope during load rejection

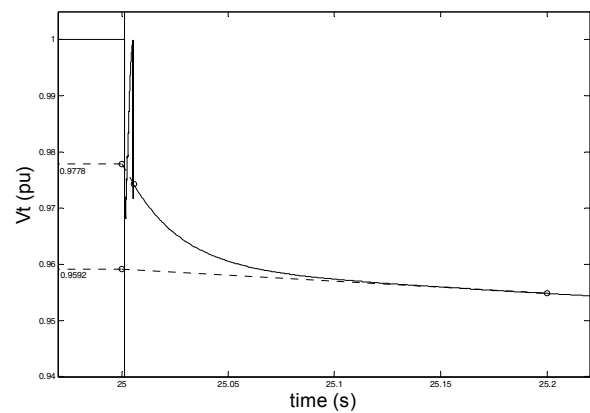

Fig. 3. Amplification of the Fig. 2

intersections of the tendencies of the terminal voltage with the terminal voltage axis at the time when the load rejection occurs.

It can be better observed in Fig. 3, where an amplification of the Fig. 2 was done providing a better view of the envelope of the armature voltage behavior during the load rejection time.

After the transient time, the terminal voltage becomes equal to the voltage induced by the field that is given by $E_f = 0.87 pu$.

Thus one can calculate the *d*-axis operational reactances using the values of A, B and C shown in Fig. 2 as in [4] and [9] the expressions (5):

$$\begin{aligned} x_d &= \frac{C}{i_{t_o}} = \frac{1-0.87}{0.1239} = 1.0492 pu \\ x'_d &= \frac{B}{i_{t_o}} = \frac{1-0.9592}{0.1239} = 0.3293 pu \\ x''_d &= \frac{A}{i_{t_o}} = \frac{1-0.9778}{0.1239} = 0.1792 pu \end{aligned} \quad (5)$$

To obtain the open circuit time constants the field current curve during the load rejection, shown in Fig. 4 and in Fig. 5, are used. T'_{do} and T''_{do} are the times required for the transient and sub-transient components of voltage to decrease to $1/e$ or 0.368 times of its initial value as in [4] and [9], so they can be obtained as: $T'_{do} = 3.8008 s$ and $T_{do} = 0.0245 s$.

B. q-axis load rejection test

The electrical conditions at the time immediately before the load rejection are: $P_o = 0.6249 pu$, $Q_o = 0.3054 pu$ (capacitive load), $V_{t_o} = 1 pu$, $i_{t_o} = iq_o = 0.6956 pu$, $v_f = 0.87 pu$, $\delta_o = \phi_o = 26.05^\circ$.

The identification process starts obtaining the A, B and C values shown in Fig. 6. Using the expressions given in [9], [4] and [10] x_q and x''_q can be calculated as shown in (6) and (7).

$$x_q = \frac{\sqrt{A^2 - C^2}}{iq_o} = \frac{\sqrt{1^2 - 0.9028^2}}{0.6956} = 0.6183 pu \quad (6)$$

$$x''_q = \frac{\sqrt{A^2 - C^2} - \sqrt{A^2 - B^2}}{iq_o} = \frac{\sqrt{1^2 - 0.9028^2} - \sqrt{1^2 - 0.9642^2}}{0.6956} = 0.2372 pu \quad (7)$$

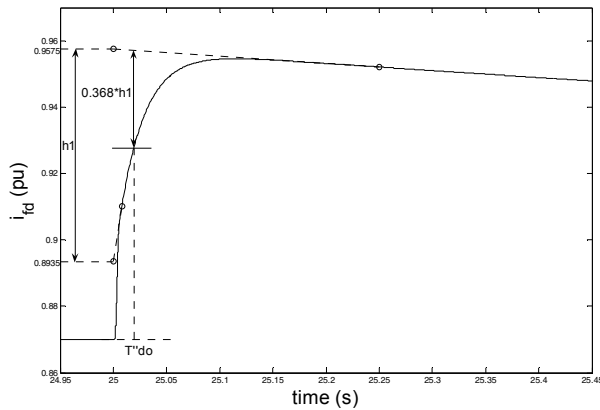

Fig. 4. Field current during the load rejection.

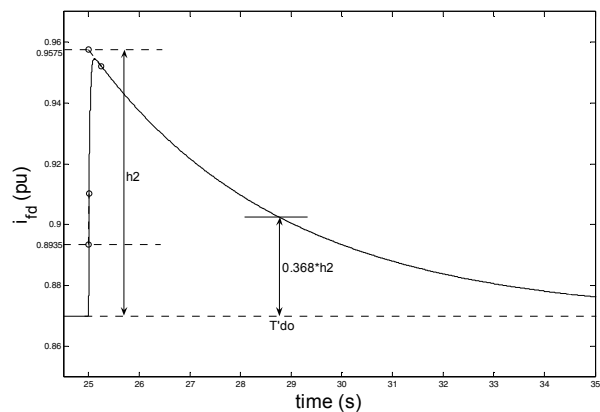

Fig. 5. Amplification of Fig. 4

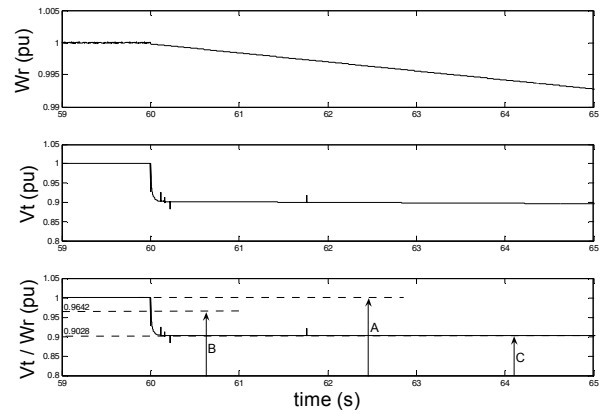

Fig. 6. Terminal voltage load rejection.

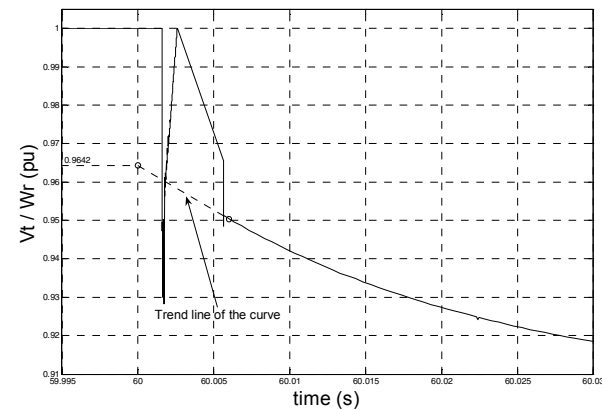

Fig. 7. Amplification of Fig. 6

C. Arbitrary axis load rejection test

The electrical quantities values at the instant immediately before the load rejection are: $P_o = 0.8437 pu$, $Q_o = 0.5222 pu$ (Inductive Load), $V_{t_o} = 1.0003 pu$, $i_{t_o} = 0.9920 pu$, $v_f = 1.7688 pu$, $\delta_o = 21.619^\circ$. Using the expressions given in [8] and the data shown in Fig. 8 and in Fig. 9 the parameters x_q and x''_q can be calculated as:

$$x_q = \frac{(V_t \text{sen} \delta)_o}{i_{q_o}} = \frac{0.3685}{0.5918} = 0.6227 pu \quad (8)$$

$$x''_q = x_q - \frac{(V_t \text{sen} \delta)_o''}{i_{q_o}} = 0.6227 - \frac{0.2541}{0.5918} = 0.1933 pu \quad (9)$$

Salient pole synchronous generators don't have x'_q but in [8] there is an expression to calculate it. T''_{qo} is the time required for the sub-transient components of voltage to decrease to $1/e$ or 0.368 times its initial value as in [4] and [9]. $T''_{qo} = 0.0328 s$.

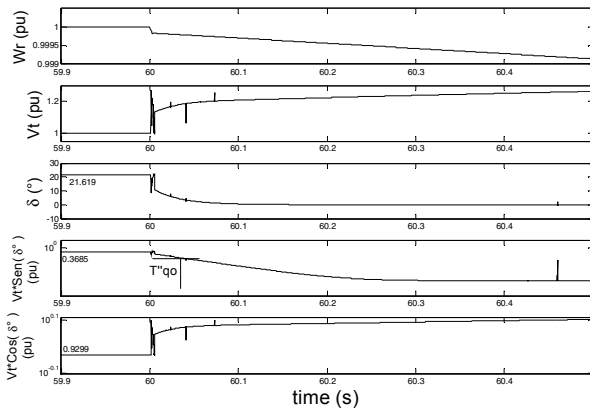

Fig. 8. Rated voltage load rejection.

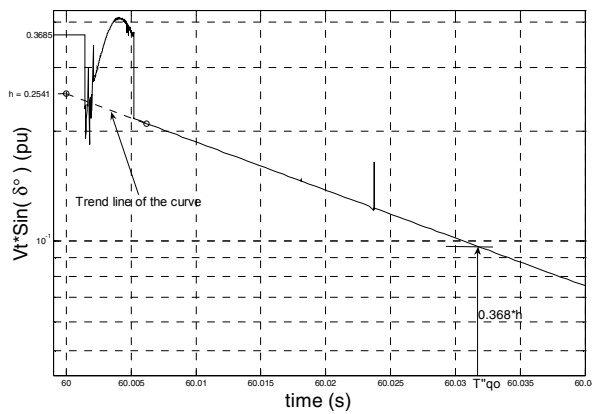

Fig. 9. Amplification of Rated voltage load rejection.

VI. TABLE OF RESULT

Table I shows the operational parameter values obtained in the load rejection simulation tests as well as the design values of the generator presented in the appendix B. The design values are used as the input of the simulations. With the data obtained in the simulations one can calculate the standard d and q parameters of the generator as in [7] as shown in the appendix A.

VII. CONCLUSIONS

It was verified through simulations using the software Matlab/Simulink/SimPowerSystems that the load rejection tests provide reliable values for the operational parameters of the synchronous generator. The values obtained in the simulation comply very well with the synchronous generator design operational parameters which were used as input in the simulations. This way one can use the simulation tests procedure and parameters calculation to show the importance of the dynamic mathematical modeling of synchronous generator and also to use it as a previous simulation to provided a guide for the procedures to be taken in the plant or in the laboratory when load rejection tests are required for parameters determina-

TABLE I
PARAMETERS IN PU

Parameters Standard	D-Axis Load Rejection	Q-Axis Load Rejection	Arbitrary Axis Load Rejection	Appendix A	
				Calculated	Design Values
T'_{do}	3.8008	-	-	-	3.7724
T''_{do}	0.0245	-	-	-	0.0238
T''_{qo}	-	-	0.0328	-	0.0334
x_d	1.0492	-	-	-	1.0495
x_q	-	0.6183	0.6227	-	0.6313
x'_d	0.3293	-	-	-	0.3320
x''_d	0.1792	-	-	-	0.1963
x''_q	-	0.2372	0.1933	-	0.2496
T'_d	-	-	-	1.1929	1.1939
T''_d	-	-	-	0.0133	0.0140
T''_q	-	-	-	0.0102	0.0132

tion. Simulations and data mathematical treatment can also be improved using simulation results.

ACKNOWLEDGMENT

The authors would like to thank very much the Brazilian electric utility "CPFL Geração" for the financial support provided in extent of the ANEEL Research and Development Program and also to thank CNPq (Brazilian National Research Council) for the scholarship offered to one of the authors during two years.

APPENDIX A

$$T''_d = T''_{do} \frac{x'_d T'_{do}}{x_d T'_d} \quad \{A-1\}$$

$$T'_d = x'_d \frac{T'_{do}}{x_d} \quad \{A-2\}$$

$$T''_q = \frac{x''_q}{x_q} T''_{qo} \quad \{A-3\}$$

$$x_q = x_{mq} + x_{ls} = 0.6313 \text{ pu}$$

$$x_d = x_{md} + x_{ls} = 1.0495 \text{ pu}$$

$$x'_d = x_{ls} + \frac{x_{md} x_{lfd}}{x_{lfd} + x_{md}} = 0.3320 \text{ pu}$$

$$x''_d = x_{ls} + \frac{x_{md} x_{lfd} x_{lkd}}{x_{md} x_{lfd} + x_{md} x_{lkd} + x_{lfd} x_{lkd}} = 0.1963 \text{ pu}$$

$$x''_q = x_{ls} + \frac{x_{mq} x_{lkq}}{x_{lkq} + x_{mq}} = 0.2496 \text{ pu}$$

$$T_{qo}'' = \frac{(x_{lkq} + x_{mq})}{\omega_b r_{kq}} = 0.0334 \text{ pu}$$

$$T_{do}' = \frac{(x_{ffd} + x_{md})}{\omega_b r_{fd}} = 3.7724 \text{ pu}$$

$$T_{do}'' = \frac{\left(x_{lkd} + \frac{x_{md} x_{ffd}}{x_{md} + x_{ffd}} \right)}{\omega_b r_{kd}} = 0.0238 \text{ pu}$$

$$T_q'' = \frac{\left(x_{lkq} + \frac{x_{mq} x_{ls}}{x_{mq} + x_{ls}} \right)}{\omega_b r_{kq}} = 0.0132 \text{ pu}$$

$$T_d' = \frac{\left(x_{ffd} + \frac{x_{md} x_{ls}}{x_{md} + x_{ls}} \right)}{\omega_b r_{fd}} = 1.1939 \text{ pu}$$

$$T_d'' = \frac{\left(x_{lkd} + \frac{x_{md} x_{ls} x_{ffd}}{x_{md} x_{ls} + x_{md} x_{ffd} + x_{ls} x_{ffd}} \right)}{\omega_b r_{kd}} = 0.0140 \text{ pu}$$

APPENDIX B

Salient pole synchronous generator design data: 6250 kVA, 4160 V, 60 Hz, 0.85 pf, 20 poles, $r_s = 0.00636 \text{ pu}$, $x_{ls} = 0.1235 \text{ pu}$, $r_{kd} = 0.03578 \text{ pu}$, $r_{kq} = 0.05366 \text{ pu}$, $r_{fd} = 0.0084 \text{ pu}$, $x_{lkd} = 0.1119 \text{ pu}$, $x_{lkq} = 0.1678 \text{ pu}$, $x_{ffd} = 0.2691 \text{ pu}$, $H = 7.11 \text{ s}$.

REFERENCES

- [1] R.H. Park, "Two-Reaction theory of synchronous machines – generalized method of analysis - part I, part II", AIEE Trans., vol. 48, 1929, pp. 716-727; vol. 52, 1933, pp.352-355.
- [2] E.C. Bortoni, J.A. Jardini, "A Standstill Frequency Response Method for Large Salient Pole Synchronous Machines," IEEE Trans on E.C, Vol. 19, No. 4, December 2004, pp. 687-691.
- [3] IEEE 115, IEEE Guide: Test Procedures for Synchronous Machines Part I - Acceptance and Performance Testing Part II-Test Procedures and Parameter Determination for Dynamic Analysis, 1995.
- [4] IEEE 1110, Guide for Synchronous Generator Modeling Practices and Applications in Power System Stability Analyses, 2002.
- [5] ANSI/NEMA MG1, Motors and Generators Revision 1, 2006.
- [6] P. Kundur, Power system stability and control. USA: McGraw-Hill, 1994.
- [7] Krause, P.C Analysis of electric machinery, McGraw Hill Book Company, 1986.
- [8] Peter Vas, Parameter Estimation, Condition Monitoring, and Diagnosis of Electrical Machines, Oxford University Press, 1993.
- [9] F.P de Mello and J.R. Ribeiro, "Derivation of Synchronous machine parameters from tests," IEEE Trans. Power Apparatus and Systems, vol. 96, July/Aug 1977, pp. 1211-1218.
- [10] J.C. Pequeña and E. Ruppert, Sobre a Determinação de Parâmetros de Geradores Síncronos para Estudos de Comportamento Dinâmico de Sistemas Elétricos, Master Thesis presented, to the FEEC/UNICAMP, Brazil, in portuguese, 2009.
- [11] IEC, Recommendations for Rotating Electrical Machinery, Part.4: Methods for Determining Synchronous Machine Quantities, 34-4A, 1985.