

MEDGREEN 2011-LB

## Smart Control of UPCQ within Microgrid Energy System

C. Benachaiba<sup>a\*</sup>, Ahmed M. A. Haidar<sup>b</sup>, M. Habab<sup>a</sup>, O. Abdelkhalek<sup>a</sup>

<sup>a</sup>University of Bechar, Bechar, BP 417, Algeria

<sup>b</sup>University Malaysia Pahang, Malaysia

---

### Abstract

One of the most popular issues in the future power distribution is the quality improvement of microgrid and the development of smart grid (SG). Many applications operating at the microgrid level can be considered as smart grid functions. This paper proposes the application of Fuzzy Logic (FL) technique within microgrid energy system based on the most modern power conditioning equipment devices such as Unified Power Quality Conditioner (UPQC). This technique is working together with the microgrid to track the disturbance of the smart grid and improve the quality of the system with a high flexibility. Furthermore, a control methodology developed based on a simulation technique to maintain the output voltage of the microgrid. Finally, experimental results show the high performance of the proposed Fuzzy Logic controller (FLC) compare to the classical proportional integration (PI).

© 2010 Published by Elsevier Ltd. Open access under [CC BY-NC-ND license](https://creativecommons.org/licenses/by-nc-nd/4.0/).

Selection and/or peer-review under responsibility of [name organizer]

*KeyWords:* Smart Controller; Microgrid; Active power conditioners; Voltage flicker; Sag; Swell; Unbalance voltage

---

### 1. Introduction

The Quality of power supply in microgrid is impaired due to several reasons such as the electronic components involved in microgrid that can lead to a variety of different power system disturbances including voltage waveforms distortion, equipment overheating, miss function in system protection, excessive neutral currents, light flicker, inaccurate reading of metering units, etc. Therefore, this degradation is seen as various phenomena. The end user of the electricity may suffer e. g. from supply interruptions, voltage dips, flicker, and harmonics and unbalance voltage. Microgrid is one of the expected local power supply system that consists of distributed generators, loads, power storage devices, heat recovery equipments and power electronics equipments [1]. Recently, the utilization of alternative energy sources (AES) is growing rapidly because of its economical and environmental benefits compared to the

conventional large power plant. The optimal values of a healthy distributed network are defined by the European Standard EN 50160 and IEEE norms [2-3].

Many AES such as Photo-Voltaic, wind turbines and fuel cell, do not generate a 50Hz voltage, so they require an interface device to regulate the AC power. The advancement of SG system is another effort to the rapidly growing energy demands and the increasing service quality. SG is the system that is able to rapidly detect, analyze and response to various perturbations by integrating intelligent devices such as advanced control method and digital telecommunication on electrical network [4]. These smart devices help to build a more flexible and invulnerable power system. UPQC is one of the developed techniques that can be utilized to enhance the quality of power supply in the microgrid and is expected that the SG can be reliable, flexible, diverse and dynamically controllable [5]. The conversion systems are properly controlled as a smart device to permit the operation of the system either interconnected to the low voltage network, or operate in stand-alone mode, with a seamless transfer from the one mode to the other [6]. In the grid connected mode, the inverter system of microgrid usually works in the constant current control mode to provide pre-set power to the utility of power system [7].

One of the most attractive structures of energy conditioner is the two back-to-back connected DC/AC fully controlled converters. In this case, depending on the control scheme, the converters may have different compensation functions [8, 9]. For example, they can function as active series and shunt filters to compensate simultaneously load current harmonics and supply voltage fluctuations. It is a versatile device that can compensate almost all power quality problems such as harmonics, unbalance, flickers, sags, swells, etc. Recently more attention is being paid on mitigation of voltage sags and swells using UPQC [10-11]. The common cause of voltage sag and swell is sudden change of line current flowing through the source impedance. Thus, the swells are not as common as sags, but the effects of a swell can be more destructive than sag. For example, the excessive over voltage during swell condition may cause breakdown of components or equipments [12]. The concept of FL is to utilize the qualitative knowledge of a system to design a practical controller [13]. For a process controlling system, a fuzzy control algorithm embeds the intuition and experience of an operator. The control doesn't need accurate mathematical model of a plant, and therefore, it suits well to a process where the model is unknown or ill-defined and particularly designed with uncertain or complex dynamics.

Implementing a smart controller of UPQC applied to the microgrid is a novel idea in this work. A grid connected UPQC is presented to investigate the flexibility and venerability of the microgrid energy system. By using the smart controller of UPQC as smart devices the performance and power quality in microgrid energy system can be improved. The paper is organized as such that, section 2 illustrates the principle operation of UPQC and the control techniques are briefly described in section 3. Section 4 presents the implementation of FLC in the UPQC. Simulation results and conclusion are provided in section 5 and 6 respectively.

## 2. Principe operation of UPQC

The UPQC applied in this work is connected to microgrid energy system which is a combination of different AES connected into power grid system. The general configuration of the UPQC is shown in Fig. 1. The UPQC has the capability of improving power quality at the point of installation on microgrid energy systems or industrial power systems. The currents of the source are sinusoidal current and the phase angles are the same as the fundamental. In another words, with the function of the UPQC, the load is equal to a resistance. As the UPQC is a combination of series and shunt active power filters (APF), two active filters have different functions. The series active filter suppresses and isolates voltage-based distortions. The shunt active filter cancels current-based distortions. At the same time, it compensates reactive current of the load and improves power factor. There are many control methods to determine the

reference value of the voltage and the current, the most famous is the instantaneous active and reactive power theory (the *pq* theory) proposed by [8].

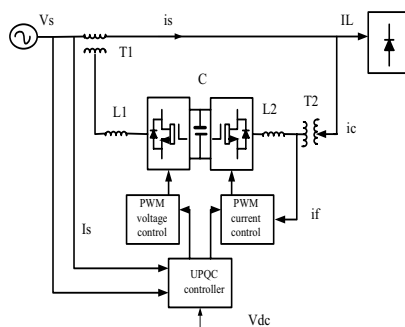

Fig. 1. General configuration of the UPQC

Fig. 2 shows an equivalent circuit of UPQC installed on the common bus, where  $V_s$  is the voltage at the power supply;  $V_{sr}$  is the series- active filter compensating voltage and  $V_l$  is the load voltage,  $i_{sh}$  is the shunt- active filter compensating current and  $V_{sr}$  [9].

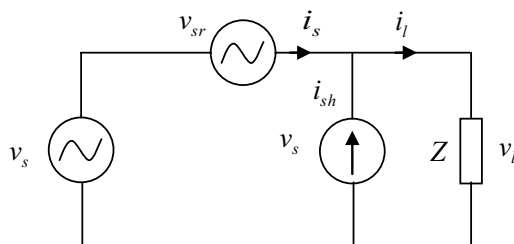

Fig. 2. Equivalent circuit of a basic UPQC

Due to the voltage distortion, the system may contain negative phase sequence and harmonic components. In general, the source voltage in Fig. 2 can be expressed as:

$$V_s + V_{sr} = V_l \tag{1}$$

To obtain a balance sinusoidal load voltage with fixed amplitude  $V$ , the output voltages of the series-APF should be given by;

$$V_{sr} = (V - V_{1p}) \sin(\omega t + \theta_{1p}) - v_{1n}(t) - \sum_{k=2}^{\infty} v_k(t) \tag{2}$$

where,

$V_{1p}$  : Positive sequence voltage amplitude fundamental frequency

$\theta_{1p}$  : Initial phase of voltage for positive sequence

$v_{1n}$  : Negative sequence component

The shunt-APF acts as a controlled current source and its output components should include harmonic, reactive and negative-sequence components in order to compensate these quantities in the load current. When the output current of shunt-APF  $i_{sh}$  is kept to be equal to the component of the load as given the following equation:

$$i_l = I_{1p} \cos(\omega t + \theta_{1p}) \sin \phi_{1p} + i_{ln} + \sum_{k=2}^{\infty} i_{lk} \quad (3)$$

$$\phi_{1p} = \varphi_{1p} - \theta_{1p} \quad (4)$$

where,

$\varphi_{1p}$  : Initial phase of current for positive sequence

As seen from the above equations that the harmonic, reactive and negative sequence current is not flowing into the power source. Therefore, the terminal source current is harmonic-free sinusoid and has the same phase angle as the phase voltage at the load terminal

$$\begin{aligned} i_s &= i_l - i_{sh} \\ &= I_{1p} \sin(\omega t - \theta_{1p}) \cos \phi_{1p} \end{aligned} \quad (5)$$

### 3. Control Strategy of UPQC

The control strategy is divided into shunt control strategy, series control strategy and DC capacitor control. The functions of each are given below:

#### 3.1. Shunt control strategy

The shunt active power filter provides the current and the reactive power compensation if the system is needed. It acts as a controlled current generator that compensates the load current to force the source current drained from the network to be sinusoidal, balanced and in phase with the positive-sequence system voltages.

#### 3.2. Series control strategy

The series active power filter provides the voltage compensation. It generates the compensation voltage that synthesized by the PWM converter and inserted in series with the supply voltage, to force the voltage at Point of Common Coupling (PCC) to become sinusoidal and balanced.

#### 3.3. DC voltage controller

In compensation process, the DC side voltage will be changed because UPQC compensates the active power and the losses of switches, etc. If the DC voltage is not the same as the rating value, the output voltage of the series active filter will not be equal to the compensation value and the compensation would not be corrected. It is the same with the shunt active filter. A PI-Controller is used in DC voltage regulator. It realizes a slower feedback control loop that is useful to correct the compensation errors that arise during transients. The DC current is added to the reference current to calculate the compensation currents. The DC voltage regulator shown in Fig. 3 is used to generate a control signal to keep the voltage

in a constant stage and this is forcing the shunt active filter to draw additional active current from the network.

The PI-controller can be expressed as,

$$G(s) = k_p + \frac{k_i}{s} \tag{6}$$

In simulation, the values of  $K_p$  and  $K_i$  are set as  $K_p=4.5766$  and  $K_i=616.1911(\text{sec})$

$G(s)$ : Transfer function of the PI-controller

$K_p$ : Proportional gain of the PI-controller

$k_i$ : Integral gain of the PI-controller

$s$ : Complex Laplace variable



Fig. 3. The DC voltage regulator

#### 4. Implementation of FLC in the UPQC

A fuzzy controller converts a linguistic control strategy into an automatic control strategy, and fuzzy rules are constructed by expert experience or knowledge database. Firstly, the error  $e(t)$  and the variation error  $\Delta e(t)$  have been placed of the angular velocity to be the input variables of the FLC. Then the output variable of the FLC is presented by the control voltage  $u(t)$ . In this work, the type of fuzzy inference engine used is Mamdani. The linguistic variables are defined as (NB, NS, Z, PS, PB) which mean big, negative small, zero, positive small and positive big respectively. The membership functions are shown in Fig. 4. The fuzzy inference mechanism used in this work is given by Eq. (7) and the fuzzy rules are summarized in Table 1.

$$\mu_{\beta}(u(t)) = \max_i [\mu_{A1'}(e(t)); \mu_{A2'}(\Delta e(t)); \mu_{B'}(u(t))] \tag{7}$$

Fuzzy output  $u(t)$  can be calculated by the centre of gravity defuzzification as:

$$u(t) = \frac{\sum_{i=1}^m \mu_{B'}(\mu_i(t)) u_i}{\sum_{i=1}^m \mu_{B'}(\mu_i(t))} \tag{8}$$

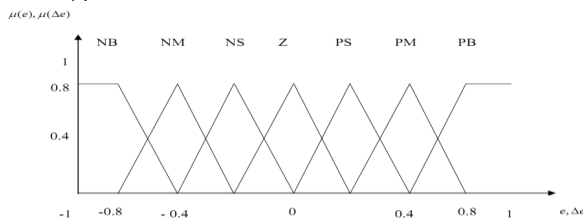

Fig. 4. Membership functions of FLC

Table 1. The decision table of FLC

u	e						
	NB	NM	NS	Z	PS	PM	PB
$\Delta e$	PB	Z	PS	PM	PB	PB	PB
	PM	NS	Z	PS	PM	PB	PB
	PS	NM	NS	Z	PS	PM	PB
	Z	NB	NM	NS	Z	PS	PM
	NS	NB	NB	NM	NS	Z	PS
	NM	NB	NB	NM	NM	NS	Z
	NB	NB	NB	NB	NM	NS	Z

As seen from table 1, each interval of each variable is divided into seven membership functions: Negative Big (*NB*), Negative Medium (*NM*), Negative Small (*NS*), Zero (*Z*), Positive Small (*PS*), Positive Medium (*PM*) and Positive Big (*PB*).

**5. Simulation Results**

The proposed new control strategy of the UPQC connected to microgrid is implemented using MATLAB/SIMULINK. The simulation of the system made on three-phase three-wire systems. The system voltage at the range of 220V-430V (Line to line) and system impedance is 1 Ω and 1 mH. The non-linear load is a three phase rectifier with a 2.5 Ω resistance and a 3.5 mH inductance at the DC side. The control of series inverter is Sinusoidal Pulse Width Modulation (SPWM) and the shunt inverter is hysteresis current control. The DC capacitor is 8.7 mF and the reference voltage is 735.6 V. Lists of figures are illustrated in this section for the compensation process of power quality at the microgrid. Figs. 5, 6 and 7 show the compensation of three phase voltage sags applying PI controller. The voltage sag occurs at 0.1s-0.2s in the voltage source. As seen from these figures, the load voltage and current have been mitigated due to the injection process by UPQC using the PI controller. It is seen that the source current is perfectly sinusoidal. Figs. 8, 9 and 10 show the simulation results of the power quality compensation of three phase voltage sags with a Fuzzy controller. The same results are obtained but the response of the Fuzzy controller for the DC voltage is more closed to the reference than the PI controller as seen in Fig. 10. The unbalance compensation of three phase current with PI is given in Figs. 11,12,13, whereas the unbalance compensation based on FLC can be seen in Figs.14,15,16. Comparing the graphical representation of Figs. 11-16, the response of both controllers are almost the same but the response of FLC at the DC voltage is more effective than the PI. Since the main controlling components are supplied by DC system so the mitigation process should be very fast and accurate, therefore, the FLC is one of the main advantages to be used in microgrid in order to enhance the SG. Lastly, Table 2 shows the THD values utilizing two controllers for harmonic distortion. As seen from this table, all the results are less than the standard values stated by IEEE 519.

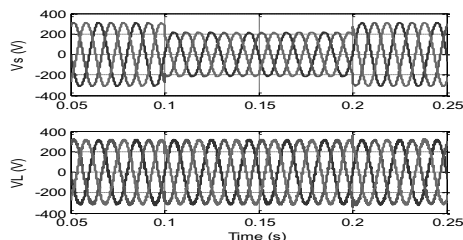

Fig. 5. The voltage during the compensation of three phase voltage sags using PI controller

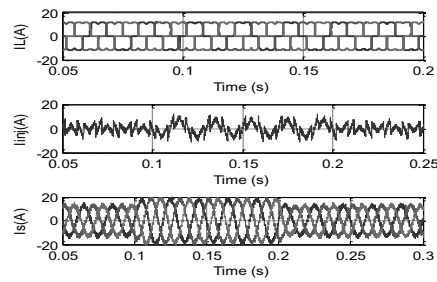

Fig. 6. The current during the compensation of three phase voltage sags using PI controller

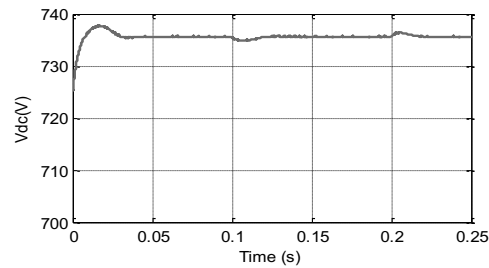

Fig. 7. The DC voltage during compensation of three phase voltage sags PI controller

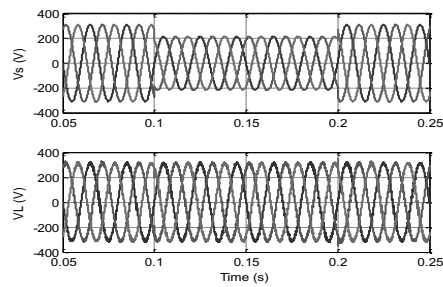

Fig. 8. The voltage during the compensation of three phase voltage sags using FLC controller

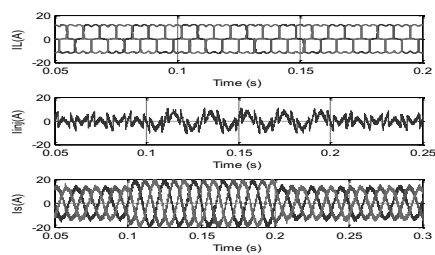

Fig. 9. The current during the compensation of three phase voltage sags using FLC controller

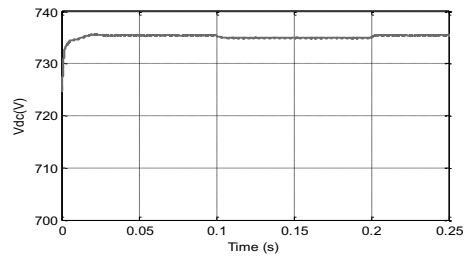

Fig. 10. The DC voltage during the compensation of three phase voltage sags using FLC controller

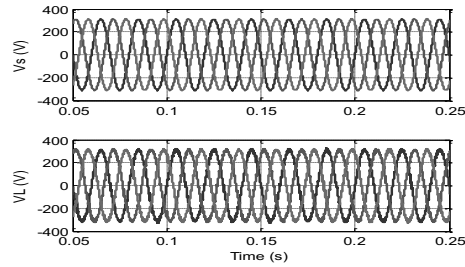

Fig. 11. The voltage during the three phase unbalance compensation using PI controller

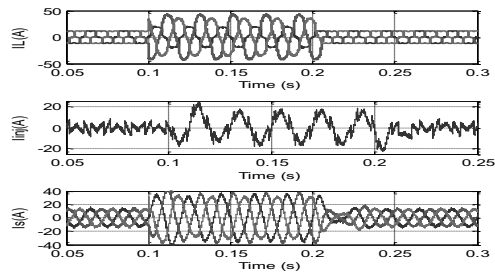

Fig. 12. The current during the three phase unbalance compensation using PI controller

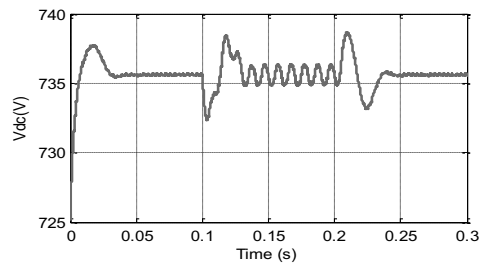

Fig. 13. The DC voltage during the three phase unbalance compensation using PI controller



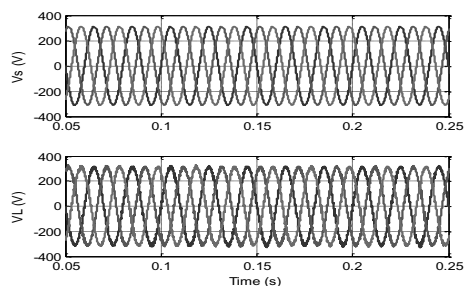

Fig. 14. The voltage during the three phase unbalance compensation using FLC controller

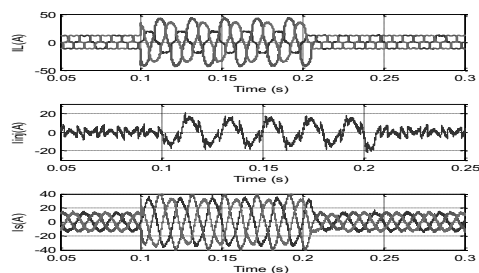

Fig. 15. The current during the three phase unbalance compensation using FLC controller

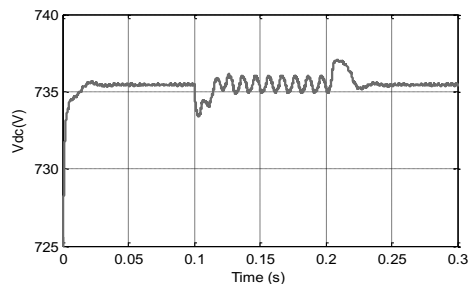

Fig. 16. The DC voltage during the three phase unbalance compensation using FLC controller

Table 2. Comparison between two controllers

Disturbances	Without UPQC		PI controller		Fuzzy controller	
	THDv	THDi	THDv	THDi	THDv	THDi
	Source	Load	Source	Load	Source	Load
Source voltage	9.49	28.62	2	3.96	2.01	4.66
Source current	0	29.27	2.23	4.18	2.11	4.93

## 6. Conclusion

This paper presents smart implementation of the UPQC within microgrid energy system based on FLC. A constructed simulation models of the control strategies and power quality enhancement are presented and discussed for some key components of the input and output parameters. The highly developed graphical facilities available in Matlab program have been used very effectively to carry out all aspects of the system implementation. The smart controller efficiency has tested on the microgrid to prove the effects of using UPQC based FLC in the low voltage level. Results illustrate the performance of FLC compare to the classical PI controller. Hence, smart controller applied on UPQC which is operating at the microgrid level can be considered as smart grid functions due to the accurate power quality improvement in the microgrid and its fast dynamic response.

## References

- [1] Xiangjun L, Yu-Jin S, Soo-Bin H. Study on power quality control in multiple renewable energy hybrid microgrid system, *Proc Power Tech. 2007 IEEE*. Lausanne; 1-5 July 2007, p. 2000–2005.
- [2] Voltage characteristics of electricity supplied by public distribution systems. *European standard EN 50160*. February 2000.
- [3] Recommended practices and requirements for harmonic control in electronic power systems. *IEEE standard 519-1992*. New York, 1993
- [4] Mak ST. Knowledge based architecture serving as a rigid framework for smart grid applications. *Innovative Smart Grid Technologies (ISGT)*; 2010, p. 1–8.
- [5] Srinivasa P. Data communication over the smart grid. *Proc Power Line Communications and Its Applications*. 2009, p. 273–279.
- [6] Georgakis D. Operation of a prototype micro-grid system based on micro-sources equipped with fast-acting power electronics interfaces. *Proc Power Electronics Specialists Conference, PESC 04. IEEE 35th Annual vol.4*; 2004, p. 2521–2526.
- [7] Balaguer IJ. Intelligent control for intentional islanding operation of microgrids. *Proc Sustainable Energy Technologies, ICSE IEEE*; 2008, p. 898–903.
- [8] Akagi H, Kanazawa Y, Nabae A. Instantaneous reactive power compensator comprising switching devices without energy storage components. *IEEE Trans. Ind. Appl.*, vol. 20; 2007, p. 625–630.
- [9] Aredes M, Watanabe EH. New control algorithms for series and shunt three-phase four-wire active power filters. *IEEE Trans. Power Delivery*, vol. 10; 1995, p. 1649–1656.
- [10] Cavalcanti MC, Azevedo GMS, Amaral BA, Neves FAS. A photovoltaic generation system with Unified Power Quality Conditioner functions. *31<sup>st</sup> Annual Conference of IEEE Indus. Elect. Society*; Nov. 6-10, 2005, p. 750–755.
- [11] Han B, Bae B, Kim H, Baek S. Combined operation of Unified Power Quality Conditioner with generation. *IEEE Trans. Power Delivery*, vol. 21; 2006, p. 330–338.
- [12] Fujita H, Akagi H. The unified power quality conditioner: the integration of series active filter and shunt active filters. *Proceedings on IEEE/PES Power Electronics Specialist Conferences*; June 1996, p.491–501.
- [13] Khadkikar V, Aganval P, Chandra A, Bany AO, Nguyen T. D. A simple new control technique for unified power quality conditioner (UPQC). *11th International Conference on Harmonics and Quality of Power*, Lake Placid, New York, USA; Sept 12-15, 2004, p.289–293.