

Active Power Exchange in Distributed Power-Flow Controller (DPFC) At Third Harmonic Frequency

P.Bhaskar Chand Yadav¹, M.Hemanth Sai²

¹ PG Scholar, Department of Electrical & Electronics Engineering, P.V.P. Siddhartha Institute of Technology Vijayawada-520007

² Assistant professor Department of Electrical & Electronics Engineering, P.V.P. Siddhartha Institute of Technology Vijayawada-520007

Abstract:- This paper presents a component within the flexible ac-transmission system (FACTS) family, called distributed power-flow controller (DPFC). The DPFC is derived from the unified power-flow controller (UPFC) with an eliminated common dc link. The DPFC has the same control capabilities as the UPFC, which comprise the adjustment of the line impedance, the transmission angle, and the bus voltage. The active power exchange between the shunt and series converters, which is through the common dc link in the UPFC, is now through the transmission lines at the third-harmonic frequency. DPFC multiple small-size single-phase converters which reduces the cost of equipment, no voltage isolation between phases, increases redundancy and there by reliability increases. The principle and analysis of the DPFC are presented in this paper and the corresponding simulation results that are carried out on a scaled prototype are also shown.

Keywords:- AC–DC power conversion, load flow control, Phase Locked Loop (PLL), dqo transformation, power-transmission control.

I. INTRODUCTION

The growing demand and the aging of networks make it desirable to control the power flow in power-transmission systems fast and reliably [1]. In the transmission line due to the transmission line impedance, different load conditions varying with time-time there is an occurrence of requirement of active and reactive power in the transmission line leads to drop in the transmission line voltage drop and increases the transmission angle between the sending and receiving end voltages. There are many conventional transmission FACTS components which help to increase the power-flow capability in the transmission lines, like TCSC, TCPAR, IPFC, and UPFC each having their own control capabilities advantages and some disadvantages. This paper presents a new component in FACTS family called distributed power-flow controller (DPFC) that is derived from the UPFC that combines conventional FACTS and D-FACTS devices, same as the UPFC, the DPFC is able to control all system parameters, such as line impedance voltage magnitude and power angle. At the same time, it provides higher reliability and lower cost. The DPFC employs several D-FACTS devices in series with the transmission line and one conventional controlled voltage-source shunt converter to provide the active power for each D-FACTS device. In order to inject a 360° voltage vector to achieve the full control capability as UPFC, there is an exchange of active power between the shunt and series converters needed, and the traditional way for active power exchange is using common DC link as UPFC. The DPFC eliminates the common dc link between the shunt and series converters. The active power exchange between the shunt and the series converter is through the transmission line at the third-harmonic frequency.

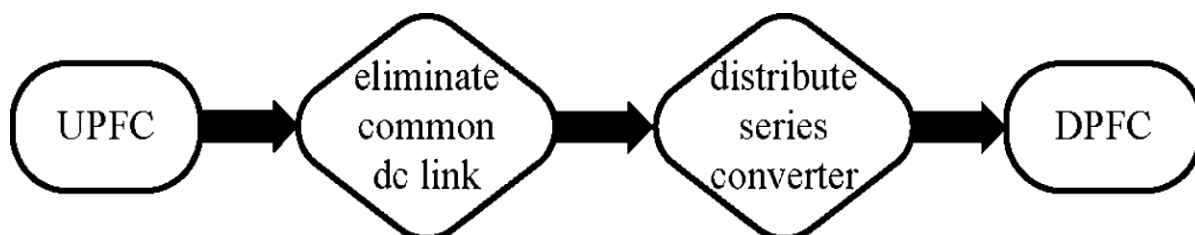

Fig. 1: Flowchart from UPFC to DPFC.

The series converter of the DPFC employs the distributed FACTS, this distributed converters are. In DPFC Concept distributed static series compensator (DSSC) is used that uses multiple low-power single-phase inverters that attach to the transmission conductor, spread along the transmission line and dynamically control

the impedance of the transmission line, allowing control of active power flow on the line. The DSSC inverters are self-powered by induction from the line itself, float electrically on the transmission conductors, and are controlled using wireless or power line communication techniques.

The Distributed Static Series Compensator or DSSC, using modules of small rated, single phase inverters and a single turn transformer (STT), along with associated controls, power supply circuits and built-in communications capability. Shunt devices such as static synchronous compensator (Statcom), have been most widely applied, and are typically used for reactive VAR compensation and voltage support. The function of the shunt converter is to compensate reactive power to the grid, and to supply the active power required by the series converter.

PRINCIPLES OF ACTIVE POWER FLOW CONTROL

For controlling power flow on transmission lines, the series elements clearly have the highest potential and impact. The real and reactive power flow, P and Q , along a transmission line connecting two voltage buses is governed by the two voltage magnitudes V_1 and V_2 and the voltage phase angle difference, $\delta = \delta_1 - \delta_2$.

$$P_{12} = \frac{V_1 V_2 \sin \delta}{X_L} \quad (1)$$

$$Q_{12} = \frac{V_1^2 - V_1 V_2 \cos \delta}{X_L} \quad (2)$$

Where X_L is the impedance of the line, assumed to be purely inductive. Control of real power flow on the line thus requires that the angle δ , or the line impedance X_L be changed. A phase shifting transformer can be used to control the angle δ . This is an expensive solution and does not allow dynamic control capability. Alternatively, a series compensator can be used to increase or decrease the effective reactive impedance X_L of the line, thus allowing control of real power flow between the two buses. The impedance change can be effected by series injection of a passive capacitive. Alternatively, a static inverter can be used to realize a controllable active lossless element, injects a synchronous fundamental voltage that is orthogonal to the line current.

II. DPFC METHODOLOGY

DPFC consists of one shunt and several series-connected converters. The shunt converter is similar as a STATCOM, while the series converter employs the D-FACTS concept, which is to use multiple single-phase converters instead of one large rated converter. Each converter within the DPFC is independent and has its own dc capacitor to provide the required dc voltage. The shunt converter can absorb active power from the grid at the fundamental frequency and inject the current back into the grid at a harmonic frequency; this harmonic current will flow through the transmission line. According to the amount of required active power at the fundamental frequency, the DPFC series converters generate a voltage at the harmonic frequency, thereby absorbing the active power from harmonic components. Assuming a lossless converter, the active power generated at fundamental frequency is equal to the power absorbed from the harmonic frequency.

Due to the unique characters of third-harmonic frequency components, the third harmonic is selected to exchange the active power in the DPFC. In a three-phase system, the third harmonic in each phase is identical, which is referred to as "zero-sequence." The zero-sequence harmonic can be naturally blocked by Y- Δ transformers, which are widely used in power system to change voltage level. Therefore, there is no extra filter required to prevent the harmonic leakage to the rest of the network.

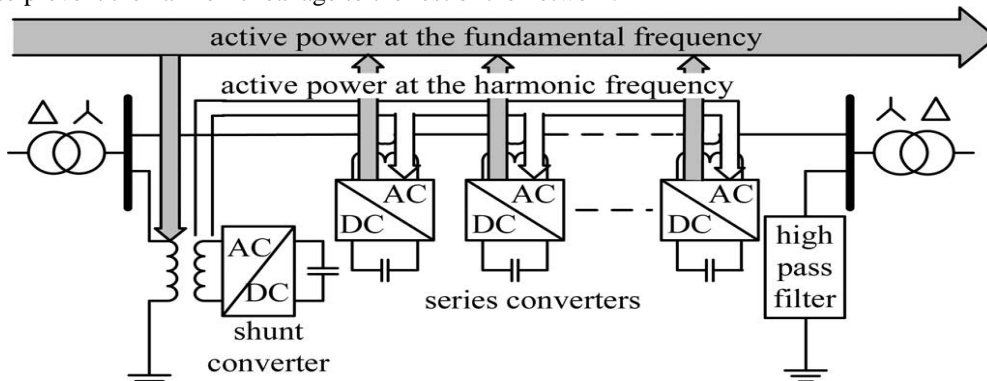

Fig. 2: Active power exchange between DPFC converters.

So high pass filter can be replaced by a cable that is connected between the neutral point of the Y-Δ transformer on the right side in Fig. 2 and the ground. Because the Δ-winding appears open circuit to the third-harmonic current, all harmonic current will flow through the Y-winding and concentrate to the grounding cable, as shown in Fig. 3.

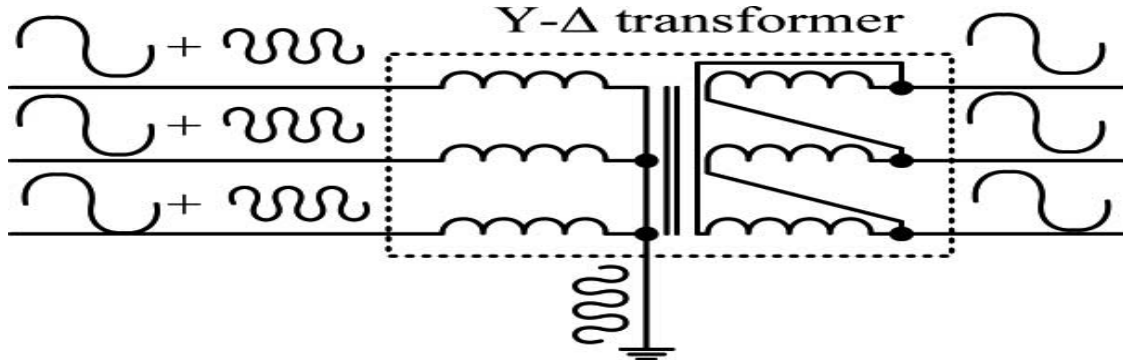

Fig. 3: Utilize grounded Y-Δ transformer to provide the path for the zero sequence third harmonic.

Another advantage of using third harmonic to exchange active power is that the way of grounding of Y-Δ transformers can be used to route the harmonic current in a meshed network. If the branch requires the harmonic current to flow through, the neutral point of the Y-Δ transformer at the other side in that branch will be grounded and *vice versa*. Fig. 3 demonstrates a simple example of routing the harmonic current by using a grounding Y-Δ transformer. Because the transformer of the line without the series converter is floating, it is open circuit for third-harmonic components. Therefore, no third-harmonic current will flow through this line. Theoretically, the third-, sixth-, and ninth-harmonic frequencies are all zero-sequence, and all can be used to exchange active power in the DPFC. As it is well known, the capacity of a transmission line to deliver power depends on its impedance. Since the transmission-line impedance is inductive and proportional to the frequency, high-transmission frequencies will cause high impedance. Consequently, the zero-sequence harmonic with the lowest frequency—third harmonic is selected.

In order to maintain the power-flow control in the transmission line the transmission line parameters that are to be controlled conventional converters are control the line impedance , control the transmission angle, to maintain voltage magnitude of the transmission line constant ,Voltage stability and voltage regulation. For these there are mainly three types of converters are employed like, unified power flow controller (UPFC), Inter line power flow controller (IPFC), Distributed power flow controller (DPFC). The UPFC is the combination of a static synchronous compensator (STATCOM) and a static synchronous series compensator (SSSC), which are coupled via a common dc link, to allow bidirectional flow of active power between the series output terminals of the SSSC and the shunt output terminals of the STATCOM. The series converter injects a four-quadrant voltage i.e 360 degree with controllable magnitude and phase. Based on the drawbacks of UPFC like requirement of high rated converters leads to increasing in cost and common dc-link failure of active power compensation, for entire system.

III. DPFC ANALYSIS

In DPFC, there is a common connection between the ac terminals of the shunt and the series converters, which is the transmission line. Therefore, it is possible to exchange the active power through the ac terminals of the converters.

The method is based on the power theory of non-sinusoidal components. According to the Fourier analysis, a non-sinusoidal voltage and current can be expressed by the sum of sinusoidal functions in different frequencies with different amplitudes.

The active power resulting from this non-sinusoidal voltage and current is defined as the mean value of the product of voltage and current. Since the integrals of all the cross product of terms with different frequencies are zero, the active power can be expressed by

$$P = \sum_{i=1}^{\infty} V_i I_i \cos \phi_i \quad (3)$$

Where V_i and I_i are the voltage and current at the i th harmonic frequency, respectively, and ϕ_i is the corresponding angle between the voltage and current. Equation (3) describes that the active power at different frequencies is isolated from each other hand the voltage or current in one frequency has no influence on the active power at other frequencies.

The independency of the active power at different frequencies gives the possibility that a converter without power source can generate active power at one frequency and absorb this power from other frequencies.

The power-flow control capability of the DPFC can be illustrated by the active power P_r and reactive power Q_r received at the receiving end. Because the DPFC circuit at the fundamental frequency behaves the same as the UPFC, the active and reactive power flow can be expressed as follows

$$(P_r - P_{r0})^2 + (Q_r - Q_{r0})^2 = \left(\frac{|V| |V_{se,1}|}{X_1} \right)^2 \quad (4)$$

Where P_{r0} , Q_{r0} , and θ are the active, reactive power flow, and the transmission angle of the uncompensated system, X_{se} , $I = \omega L_{se}$ is the line impedance at fundamental frequency, and $|V|$ is the voltage magnitude at both ends. In the PQ -plane, the locus of the power flow without the DPFC compensation $f(P_{r0}, Q_{r0})$ is a circle with the radius of $|V|/2/X_1$ around the center defined by coordinates $P = 0$ and $Q = |V|^2/2X_1$. Each point of this circle gives the P_{r0} and Q_{r0} values of the uncompensated system at the corresponding transmission angle θ . The boundary of the attainable control range for P_r and Q_r is obtained from a complete rotation of the voltage $V_{se,1}$ with its maximum magnitude. Fig. 4 shows the control range of the DPFC with the transmission angle θ .

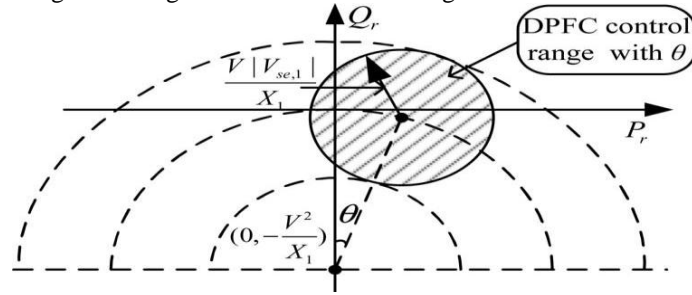

Fig. 4: DPFC active and reactive power control range with the transmission angle θ .

To ensure the series converters to inject a 360° rotatable voltage, an active and reactive power at the fundamental frequency is required. The reactive power is provided by the series converter locally and the active power is supplied by the shunt converter. This active power requirement is given by

$$P_{se,1} = \text{Re}(V_{se,1} I_1^*) = \frac{X_1}{|V_r|^2} |S_r| |S_{r0}| \sin(\phi_{r0} - \phi_r) \quad (5)$$

Where ϕ_0 is the power angle at the receiving end of the uncompensated system, which equals $\tan^{-1}(P_{r0}/Q_{r0})$ and ϕ is the power angle at receiving end with the DPFC compensation. The line impedance X_1 and the voltage magnitude $|V_r|$ are constant; therefore, the required active power is proportional to $|S_r| |S_{r0}| / \sin(\phi_0 - \phi)$, which is two times the area of the triangle that is formed by the two vectors S_{r0} and S_r . Consequently, the required active power by the series converter can be written as follows:

$$P_{se,1} = CA_{(0,r0,r)} \quad (6)$$

Where the coefficient $C = 2X_1/|V_r|^2$ and $A_{(0,r0,r)}$ is the area of the triangle $(0, S_{r0}, S_r)$. The angle difference $\phi_0 - \phi$ can be positive or negative, and the sign gives the direction of the active power through the DPFC series converters. The positive sign means that the DPFC series converters generate active power at the fundamental frequency and *vice versa*. The active power requirement varies with the controlled power flow, and the active power requirement has its maximum when the vector $S_r - S_{r0}$ is perpendicular to the vector S_{r0} , as shown in Fig. 5.

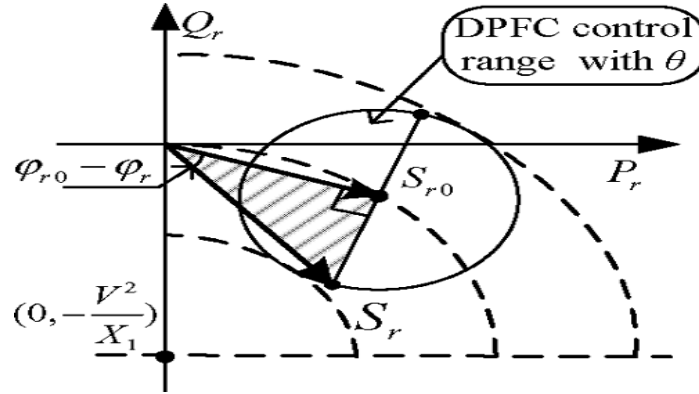

Fig. 5: Maximum active power requirement of the series converters.

$$P_{se,1,max} = \frac{|X_1||S_{r0}|}{|V_r|^2} |S_{r,c}| \quad (7)$$

Where $|S_{r,c}|$ is the control range of the DPFC. Each converter in the DPFC generates two frequency voltages at the same time. Accordingly, the voltage rating of the each converter should be the sum of the maximum voltage of the two frequencies component

$$V_{se,max} = |V_{se,1,max}| + |V_{se,3,max}|. \quad (8)$$

During the operation, the active power requirement of the series converter varies with the voltage injected at the fundamental frequency. When the requirement is low, the series voltage at the third-harmonic frequency will be smaller than $|V_{se,3,max}|$. This potential voltage that is between $V_{se,3}$ and $|V_{se,3,max}|$ can be used to control the power flow at the fundamental frequency, thereby increasing the power-flow control region of the DPFC. When $S_{r,c}$ is perpendicular to the uncompensated power S_{r0} , the series converters require maximum active power, and the radius of the DPFC control region is given by

$$|S_{r,c}| = \frac{|V_r||V_{se,1,max}|}{X_1}. \quad (9)$$

If $S_{r,c}$ is in the same line as S_{r0} , the series converters only provide the reactive compensation and the boundary of the DPFC control region will extend to

$$|S_{r,c}| = \frac{|V_r|(|V_{se,1,max}| + |V_{se,3,max}|)}{X_1}. \quad (10)$$

It shows that the control region of the DPFC can be extended to a shape that is similar as an ellipse, as shown

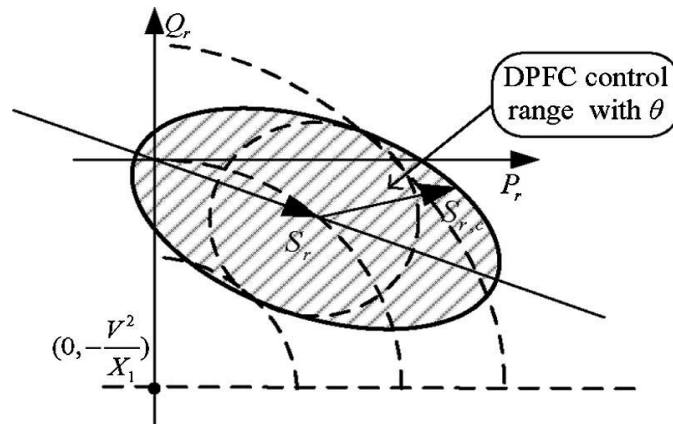

Fig.6. DPFC power-flow control range.

IV. SIMULATION RESULTS & OUTPUT ANALYSIS

DPFC simulink diagram used in this paper consists of one shunt converter of high rating and one series converter per phase of low rating attached to the transmission line with a single turn transformer (STT).

DPFC Simulation Diagram

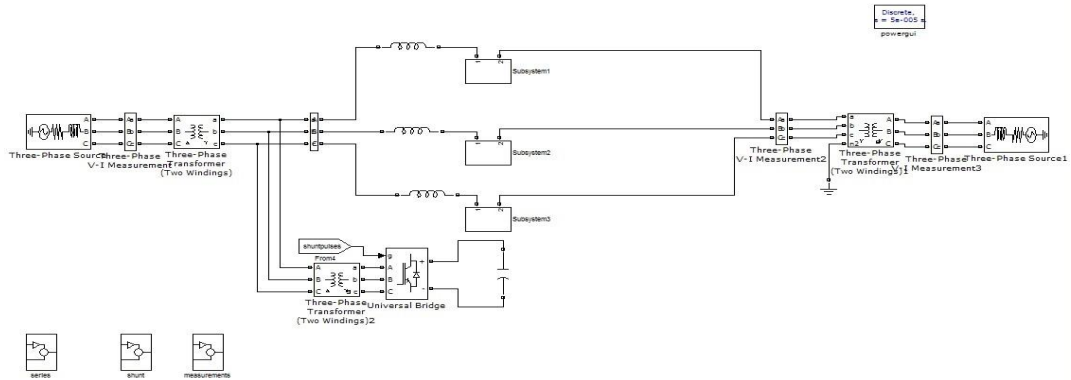

FIG. 7: Simulink model of DPFC converter

Figs. 8–10 show one operation point of the DPFC setup. In this paper, only the waveforms in one phase are shown. The voltage injected by the series converter, the current through the line, and the voltage and current at the Δ side of the transformer are illustrated.

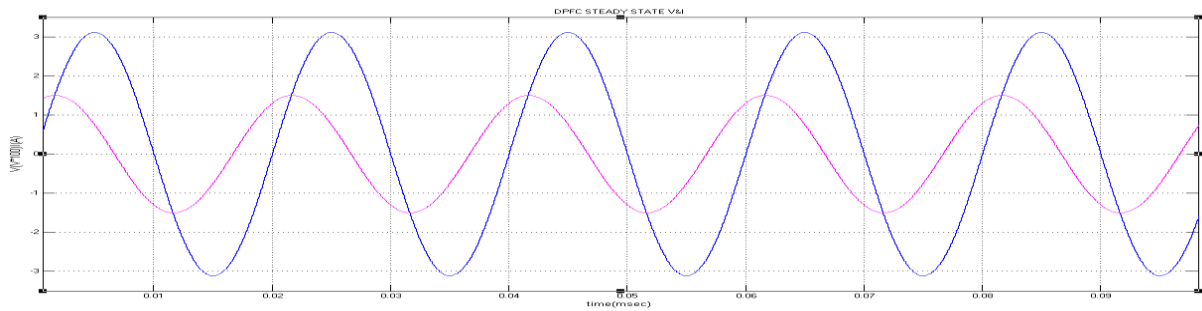

FIG. 8: Simulation result of Vs & Is at steady state response

The above waveform in fig.8 demonstrates the third-harmonic filtering by the Y– Δ transformers. There is no third-harmonic current or voltage leaking to the Δ side of the transformer is demonstrate for a discrete period of 0.29m sec

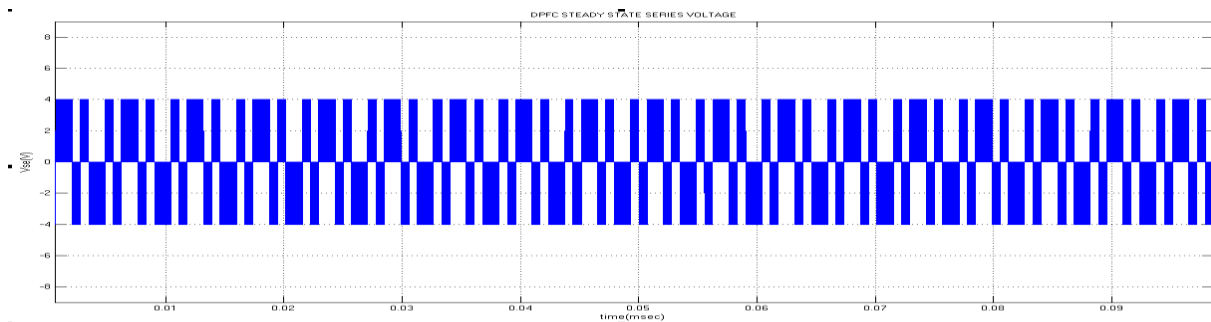

FIG.9: Steady state response of DPFC: Series converter voltage

The voltage injected by the series converter also contains two frequency components in Fig.9. The amplitude of the pulse width modulated (PWM) waveform represents the dc-capacitor voltage, which is well maintained by the third-harmonic component in steady state is obtained from the above waveform.

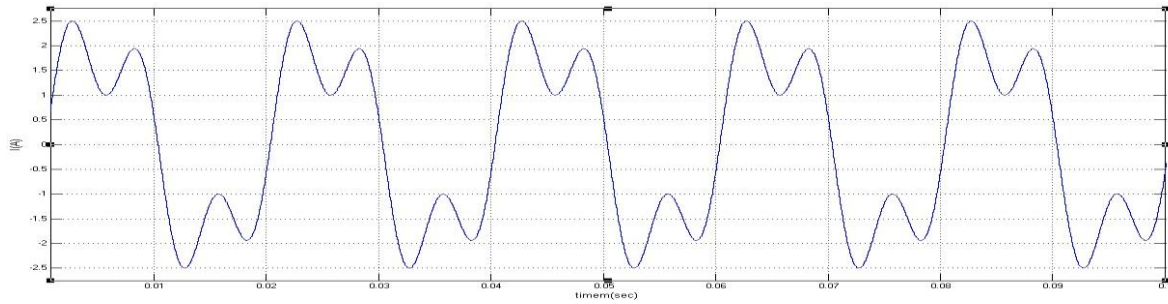

FIG.10: Steady state response of DPFC: Line current

The constant third-harmonic current injected by the shunt converter evenly disperses to the three phases and is superimposed on the fundamental current, as shown in Fig.10. upto 0.29 msec by generating a discrete PWM pulse signals by the shunt converter is represented in above waveform.

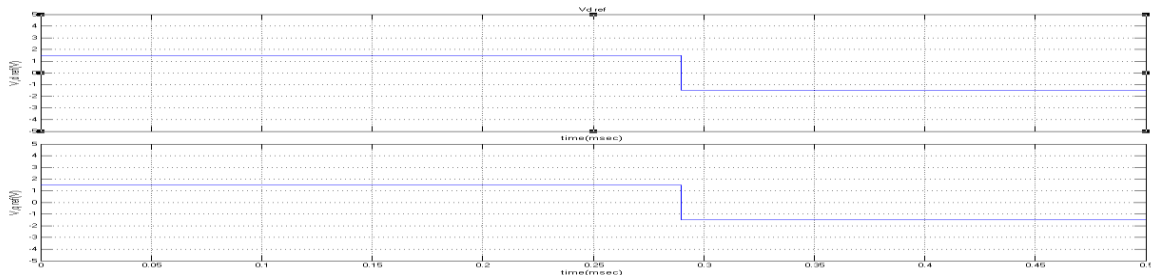

FIG.11: Reference voltage for the series converters

Fig.11 illustrates the step response for a period of 0.29msec, a step change of the fundamental reference voltage of the series converter is made, which consists of both active and reactive variations, the dc voltage of the series converter is stabilized before and after the step change.

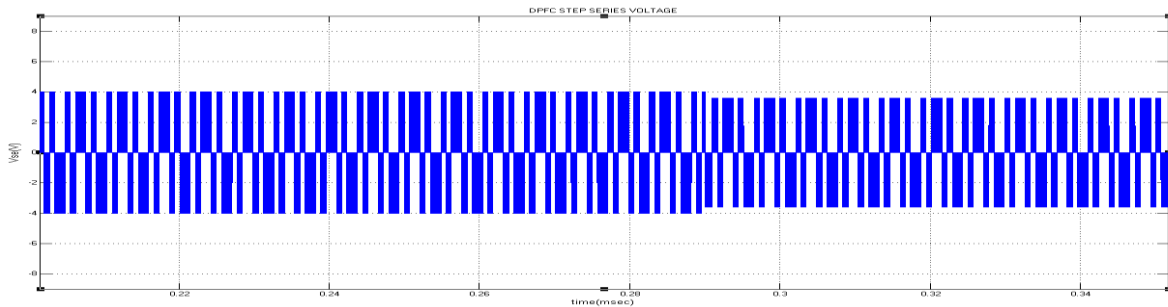

FIG.12: Step response of DPFC series converter voltage

Fig.12 illustrates the step response of the active power injected by the series converter and stabilization of transmission line before and after step response, by injecting a voltage at fundamental frequency by the series converter.

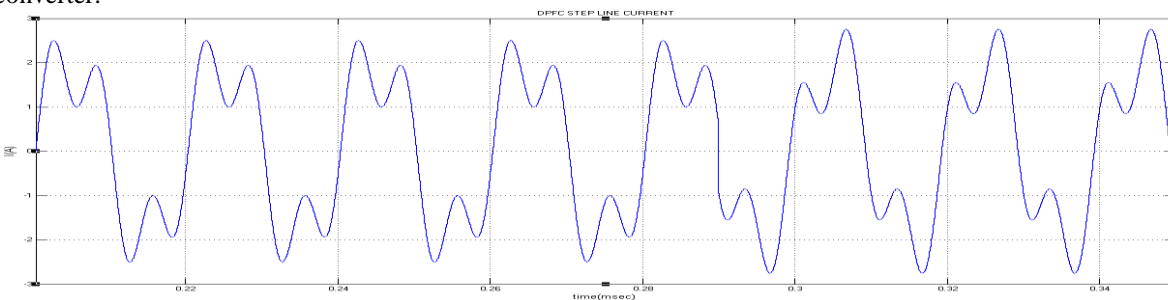

FIG.13: Step response of DPFC line current

Fig.13 illustrates the amount of active and reactive power injected by the DPFC converter control by injecting third harmonic current by the shunt converter superimposed with the transmission line fundamental current using PLL technique.

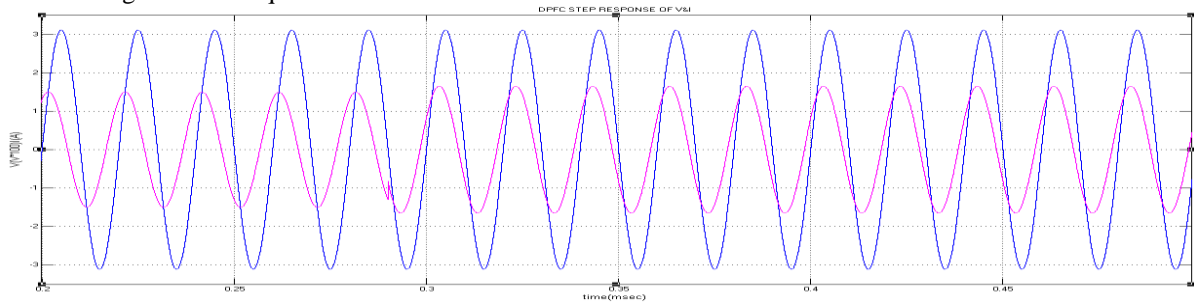

FIG.14: Step response of the DPFC bus voltage and current

Fig.14 represents the step response of bus voltage and current at the Δ side of the transformer, before and after the step response .i.e. up to 0.29msec and after 0.29msec.there is an increase of bus current.

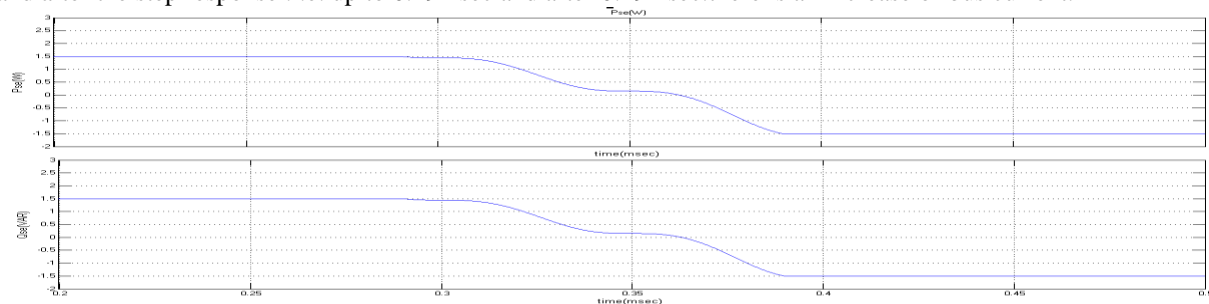

FIG.15: Step response of the DPFC active and reactive power injected by the series converter at the fundamental frequency

Fig.15 illustrated the amount of active and reactive power injected by the series converter, for step response 0.29msec generated by the discrete PWM generator. After 0.29msec the DPFC converter stop the active and reactive power injection as we use a discrete time of 0.29msec only.

V. CONCLUSION

This paper has presented a facts component called DPFC. The DPFC derived from the UPFC and inherits the control capability of the UPFC, which is the simultaneous adjustment of the line impedance, the transmission angle, and the bus-voltage magnitude. The common dc link between the shunt and series converters, which is used for exchanging active power in the UPFC, is eliminated. This power is now transmitted through the transmission line at the third-harmonic frequency. The series converter of the DPFC employs the D-FACTS concept, which uses multiple small single-phase converters instead of one large-size converter. The reliability of the DPFC is greatly increased because of the redundancy of the series converters. The total cost of the DPFC is also much lower than the UPFC, because no high-voltage isolation is required at the series-converter part and the rating of the components of is low. Hence the active power transfer between shunt and series converters the makes the transmission line voltage constant and there by the transmission angle and by injecting active power and reactive power the transmission line impedance are decreased.

REFERENCES

- [1]. Y.-H. Song and A. Johns, Flexible ac Transmission Systems (FACTS) (IEEPwer and Energy Series), vol. 30. London, U.K.: Institution of Electrical Engineers, 1999.
- [2]. N. G. Hingorani and L. Gyugyi, Understanding FACTS : Concepts and Technology of Flexible AC Transmission Systems. New York: IEEE Press, 2000.
- [3]. L.Gyugyi, C.D. Schauder, S. L.Williams, T. R. Rietman,D. R. Torgerson, andA. Edris, "The unified power flowcontroller:Anewapproach to power transmission control," IEEE Trans. Power Del., vol. 10, no. 2, pp. 1085–1097, Apr. 1995.
- [4]. A.-A. Edris, "Proposed terms and definitions for flexible ac transmissionsystem (facts)," IEEE Trans. Power Del., vol. 12, no. 4, pp. 1848–1853,Oct. 1997.
- [5]. K. K. Sen, "Sssc-static synchronous series compensator: Theory, modeling,and application," IEEE Trans. Power Del., vol. 13, no. 1, pp. 241–246,Jan. 1998.

- [6]. M. D. Deepak, E. B. William, S. S. Robert, K. Bill, W. G. Randal, T. B. Dale, R. I. Michael, and S. G. Ia A distributed static series compensator system for realizing active power flow control on existing power lines,” IEEE Trans. Power Del., vol. 22, no. 1, pp. 642–649, Jan.2007.
- [7]. D. Divan and H. Johal, “Distributed facts—A new concept for realizing grid power flow control,” in Proc. IEEE 36th Power Electron. Spec. Conf.(PESC), 2005, pp. 8–14.
- [8]. Y. Zhihui, S.W. H. de Haan, and B. Ferreira, “Utilizing distributed power flow controller (dpfc) for power oscillation damping,” in Proc. IEEE Power Energy Soc. Gen. Meet. (PES), 2009, pp. 1–5.
- [9]. Y. Zhihui, S. W. H. de Haan, and B. Ferreira, “Dpfc control during shunt converter failure,” in Proc. IEEE Energy Convers. Congr. Expo. (ECCE), 2009, pp. 2727–2732.
- [10]. Y. Sozer and D. A. Torrey, “Modeling and control of utility interactive inverters,” IEEE Trans. Power Electron., vol. 24, no. 11, pp. 2475–2483, Nov. 2009.
- [11]. M. Mohaddes, A. M. Gole, and S. Elez, “Steady state frequency response of statcom,” IEEE Trans. Power Del., vol. 16, no. 1, pp. 18–23, Jan. 2001.