

Modeling and Simulation of Space Vector Pulse Width Modulation based Permanent Magnet Synchronous Motor Drive using MRAS

P.Nagasekhar Reddy

Abstract—The Permanent Magnet Synchronous Motors (PMSM) is extensively used in low and mid power applications such as robotics, adjustable speed drives, electric vehicles and also in industrial automation. The MRAS is based on the comparison of the outputs of two estimators. The first is independent of the observed variable named as model reference. The second is the adjustable one. The error between the two models feed an adaptive mechanism to turn out the observed variable. This paper presents a detailed modeling of PMSM and a novel space vector pulse width modulation (SVPWM) based control of permanent magnet synchronous motor (PMSM) drive by using a Model Reference Adaptive System (MRAS) for estimating rotor position angle and speed based on a stator current estimator. The three-phase, two-level voltage source inverter (VSI) has a quite simple design and generates a low-frequency output voltage with controlled amplitude and frequency by programming gating pulses at high-frequency. The whole drive system is simulated in Matlab/Simulink based on the mathematical modeling of the system and the results are presented.

Index Terms— SVPWM, PI controller, PMSM, model reference adaptive system (MRAS), mathematical modeling, MATLAB, About four key words or phrases in alphabetical order, separated by commas.

I. INTRODUCTION

In the earlier years permanent magnet synchronous motor (PMSM) has become more attention because of properties such as high efficiency, high torque, high power, small volume and accurate speed control. These permanent magnet synchronous motors are used in the applications such as in chemical industry, texturing plants, glass industry, transport systems, electrical household appliances, ship engines, robotic automation, and escalators. Various speed control methods like V/f control, field oriented control and direct torque control are the most for the speed control of permanent magnet synchronous motors[1]. The development of a two-axis circuit model for a permanent magnet synchronous motor (PMSM) by taking machine magnetic parameter variations and core loss into account was described in [2,3]. The detailed modeling of a permanent magnet synchronous motor is described and presented in [4, 5]. The typical construction of a PMSM consists of a three phase stator winding and a solid iron rotor with permanent magnets attached to its surface or inserted into the rotor body. A permanent magnet synchronous motor (PMSM) is a motor that uses permanent magnet to produce the air gap magnetic field rather than using electromagnets.

Permanent magnet synchronous motor control system mainly consists of two parts, the main drive circuit and the control circuit. The main drive circuit topology remains basically unchanged, while the study of the control system focuses on the control circuit and control strategies. The construction of the PMSM results in a magnetic field fixed to the rotor position. Since such machines are not capable of directly starting from the mains, excitation by voltage source inverters (VSI) controlled by field orientation is required. Recent days the space vector pulse width modulation and fuzzy logic based control of PMSM drives is becoming popular [6]. In the proposed control of PMSM, the model reference adaptive system (MRAS) is used for the online estimation of flux linkage variations. The estimated variation of flux is then processed to obtain certain PMSM model parameter values. These values are then used as parameters of block which is designed for the reference signal shaping. However, this approach does not ensure the accuracy of decoupling. Both, the decoupling accuracy and the reference signal shaping are presented in [7]. In several cases the MRAS based estimators for motor mechanical parameters are used as described in [8,9]. In order to control the speed of PMSM several closed loop speed loop control systems such as sensorless control [10] and direct torque control [11] schemes are familiar. In this paper a novel space vector pulse width modulation based control of PMSM drive using MRAS is presented by using MATLAB/SIMULINK.

II. MODELING OF PMSM

The detailed modeling of PMSM drive system is required for proper simulation of the system. The dynamic model of PMSM without damper winding has been developed on rotor reference frame using the following assumptions:

- 1) Saturation is neglected.
- 2) The prompted EMF is sinusoidal.
- 3) Eddy currents and hysteresis losses are negligible.
- 4) The field current dynamics are neglected.

The d-q model has been developed on rotor reference frame as shown in Fig.1.

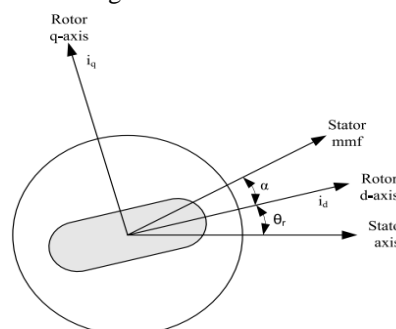

Fig.1. d-q model of Permanent magnet synchronous motor

Manuscript received August, 2013.

Mr. P.Nagasekhara Reddy, Sr.Assistant Professor, Department of Electrical and Electronics Engineering,MGIT, Hyderabad-500075, Andhra Pradesh, India.

The voltage equations of the PMSM with reference to rotor reference frame is

$$Vq = R_s i_q + \omega_r \lambda_d + \rho \lambda_q$$

$$Vd = R_s i_d - \omega_r \lambda_q + \rho \lambda_d$$

The flux Linkages equations are given by

$$\lambda_q = L_q i_q$$

$$\lambda_d = L_d i_d + \lambda_f$$

Substituting equations 3 and 4 in 1 and 2 we have the voltage equations as,

$$Vq = R_s i_q + \omega_r (L_d i_d + \lambda_f) + \rho L_q i_q$$

$$Vd = R_s i_d - \omega_r L_q i_q + \rho L_d i_d + \lambda_f$$

The voltage equations are represented in matrix form as

$$\begin{bmatrix} V_q \\ V_d \end{bmatrix} = \begin{bmatrix} R_s + \rho L_q & \omega_r L_d \\ -\omega_r L_q & R_s + \rho L_d \end{bmatrix} \begin{bmatrix} i_q \\ i_d \end{bmatrix} + \begin{bmatrix} \omega_r \lambda_f \\ \rho \lambda_f \end{bmatrix}$$

The developed torque of PMSM is being given by

$$T_e = \frac{3}{2} \left(\frac{P}{2} \right) (\lambda_d i_q - \lambda_q i_d)$$

The mechanical Torque equation is

$$T_e = T_L + B \omega_m + J \frac{d \omega_m}{dt}$$

The rotor mechanical speed form from above equation is

$$\omega_m = \int \left(\frac{T_e - T_L - B \omega_m}{J} \right) dt$$

$$\omega_m = \omega_r \left(\frac{2}{P} \right)$$

Where ω_r -is the rotor electrical speed.

ω_m -is the rotor mechanical speed

III. SPACE VECTOR PULSE WIDTH MODULATION

In recent years VSI is widely used to generate a 3-phase variable frequency and variable voltage ac supply required for variable speed AC drives. The ac voltage is defined by two characteristics, namely amplitude and frequency. Hence, it is essential to work out an algorithm that permits control over both of these quantities. PWM controls the average output voltage over a sufficiently small period called sampling period or subcycle, by producing pulses of variable duty-cycle. The three-phase, two-level voltage source inverter (VSI) has a simple structure and generates a low-frequency output voltage with controllable amplitude and frequency by programming high-frequency gating pulses. In this VSI, there are a total of 8 states (n^3). The V_1 to V_6 vectors are known as active voltage vectors and the remaining two vectors are known as zero voltage vectors. The three-phase, two-level, six pulse voltage source inverter (VSI), there are six non-zero active voltage space vectors and two zero voltage space vectors as shown in Fig.2. The six active voltage space vectors can be represented as

$$\bar{V}_k = \frac{2}{3} V_{dc} \exp \left[j(k-1) \frac{\pi}{3} \right] \quad k = 1, 2, \dots, 6$$

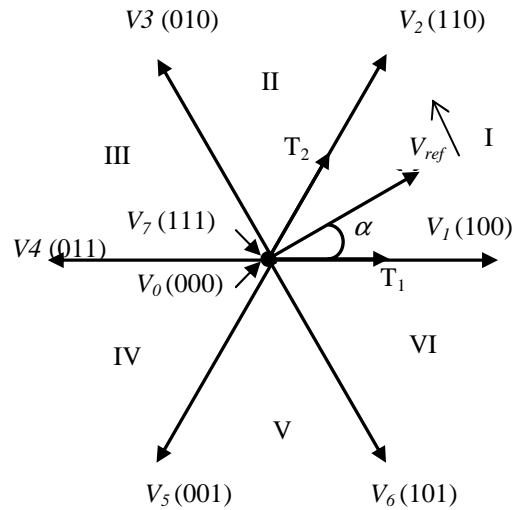

Fig.2. Possible voltage space vectors and sector identification

The reference voltage space vector (V_{ref}) represents the desired value of the fundamental components for the output phase voltages. In the space vector approach V_{ref} can be constructed in an average manner. The reference voltage vector (V_{ref}) is sampled at equal intervals of time, T_s referred to as sampling time period. The possible voltage vectors that can be produced by the inverter are applied for different time durations within a sampling time period such that the average vector produced over the T_s is equal to V_{ref} , both in magnitude and angle. It has been established that the vectors to be used to generate any sample are the zero voltage vectors and the two active voltage vectors forming the boundary of the sector in which the sample lies.

IV. MODEL REFERENCE ADAPTIVE SYSTEM (MRAS)

A block diagram of the proposed MRAS- based PMSM rotor speed estimator is shown in Fig.3. The reference model calculates instantaneous reactive power (Q_{ref}) and the adjustable model computes steady-state reactive power (Q_{est}). The instantaneous and steady state reactive power are compared to form the error signal. The error signal is then passed through an adaptation mechanism to estimate the rotor speed. The estimated rotor speed based on the computation is used to tune the adaptable model until the two reactive powers (Q_{ref} and Q_{est}) become identical. The proposed Model reference adaptive System, continuous monitoring of speed error signal and reactive power error signal is required otherwise positive feed-back may take place and the system may become unstable.

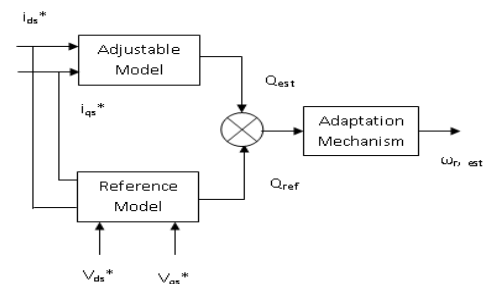

Fig.3. Functional block diagram of MRAS

V. PROPOSED CONVENTIONAL SVPWM

The block diagram of space vector pulse width modulation control of permanent magnet synchronous motor (PMSM) drive based on model reference adaptive system (MRAS) is shown in Fig.4. The phase currents are sensed from the motor through the closed loop control and are then transformed to

ALGORITHM BASED PMSM DRIVE

2-phase stationary elements. The transformed stationary elements are passed to MRAS after converting them in to rotating elements. The estimated speed of MRAS compares with the reference speed of input and uses from this speed as the real speed of machine.

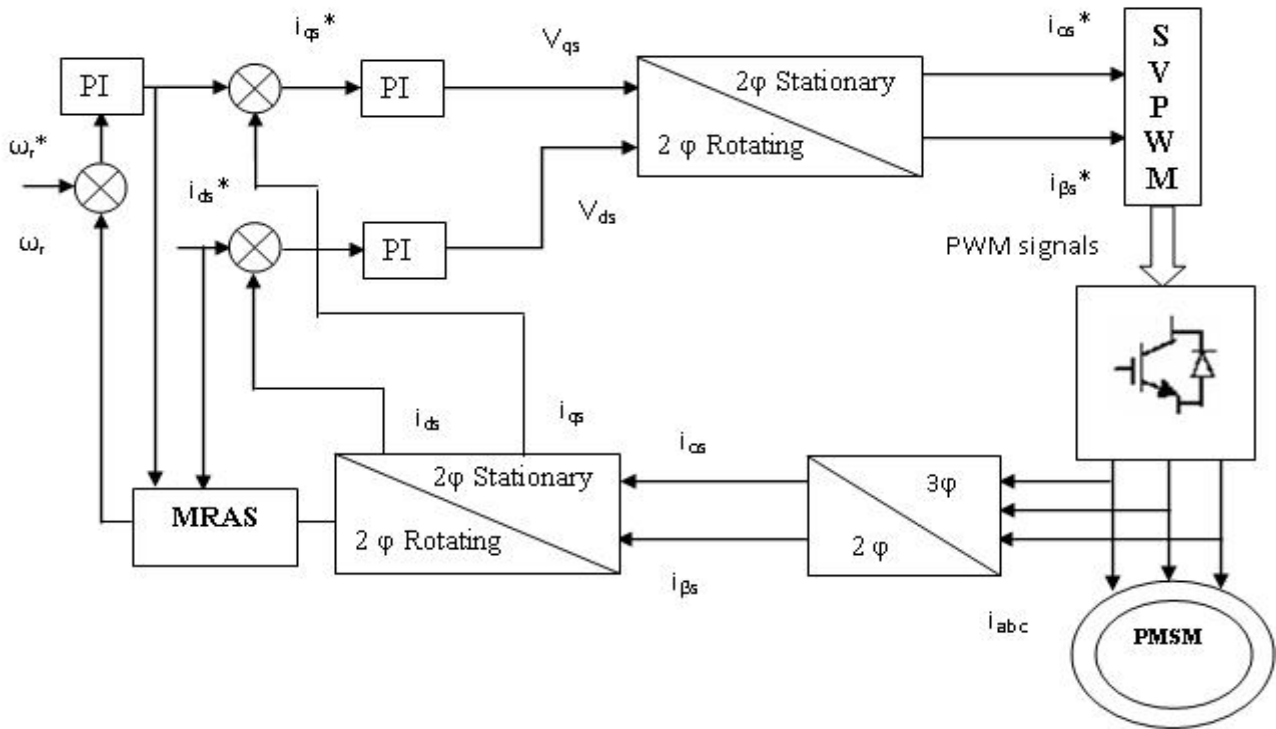

Fig.4. Block diagram of SVPWM based Permanent Magnet Synchronous Motor Drive using MRAS

The MRAS principle is based on the comparison of the outputs of two estimators. The first is independent of the observed variable named as model reference. The second is the adjustable one. The error between the two models feed an adaptive mechanism to turn out the observed variable. The error signals are passed through the controllers to determine the PWM pulses for the 3-phase inverter through the space vector control algorithm.

VI. SIMULATION RESULTS:

In this paper, a model reference adaptive system (MRAS) for control of space vector pulse width modulation based PMSM drive scheme has been implemented by using MATLAB/SIMULINK. The three phase currents, direct and quadrature axis currents and voltages are shown from Fig.5. to Fig.9. The Transformed direct and quadrature axis stator voltages from three phase voltages is shown in Fig.10. The rotor angle and corresponding rotor speed of PMSM drive is shown from Fig.11. to Fig.12. According to this control approach the reference voltage vector is synthesized with the space vector modulation algorithm. The speed error of the proposed drive system and resultant electromagnetic torque of a PMSM drive is shown in Fig.13 and Fig.14 respectively. The space vector modulation algorithm has lower harmonic current and consequently lower torque ripple. The simulation results were satisfactory in terms of estimation errors, robustness of the PMSM drive for different operating conditions.

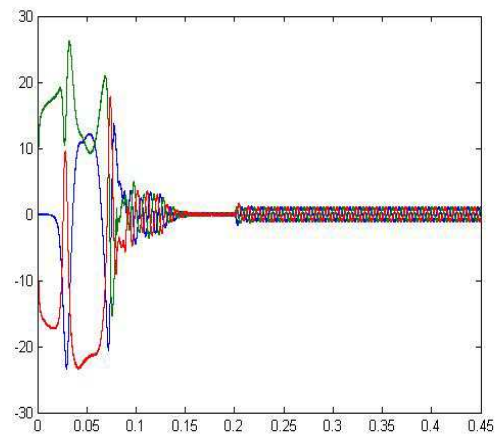

Fig.5. The three phase currents of PMSM Drive

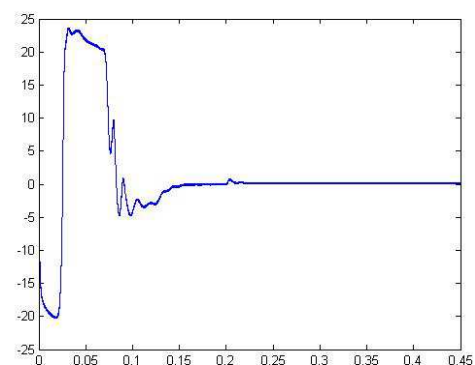

Fig.6. Direct axis stator current of PMSM drive

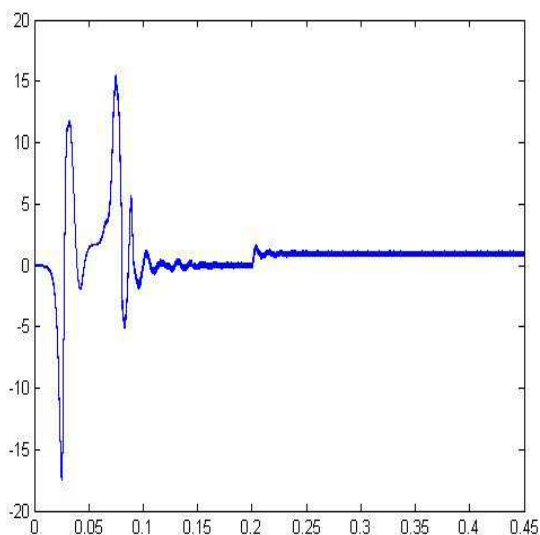

Fig.7. Quadrature axis stator current of PMSM drive

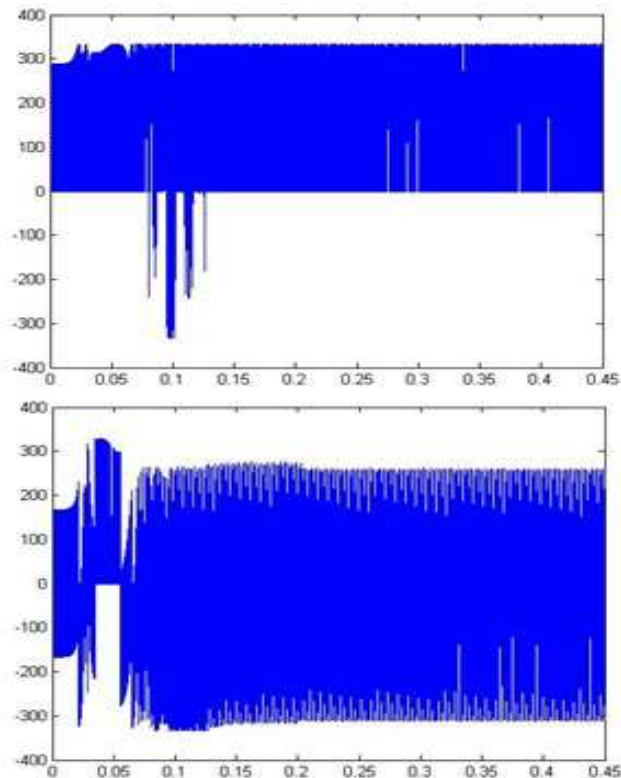

Fig.10. Transformed direct and quadrature axis stator voltages from three phase voltages

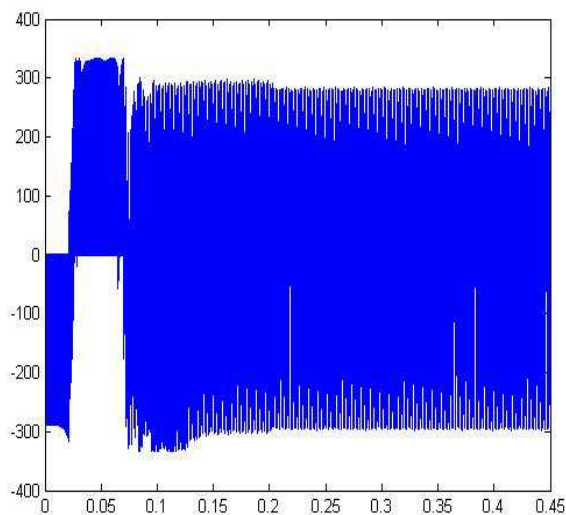

Fig.8 Direct axis stator voltage of PMSM drive

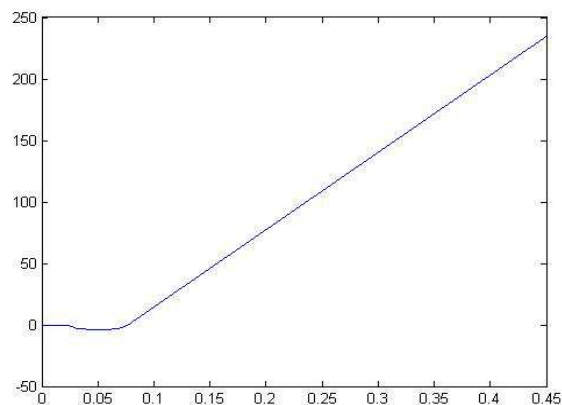

Fig.11. Rotor angle of PMSM drive

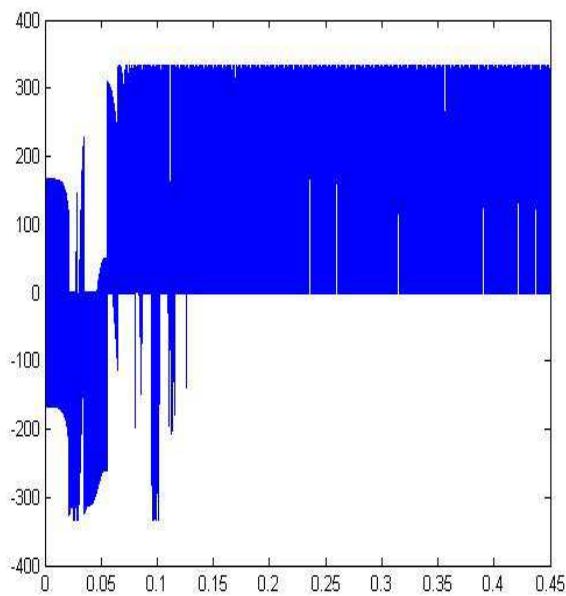

Fig.9. Quadrature axis stator voltage of PMSM drive

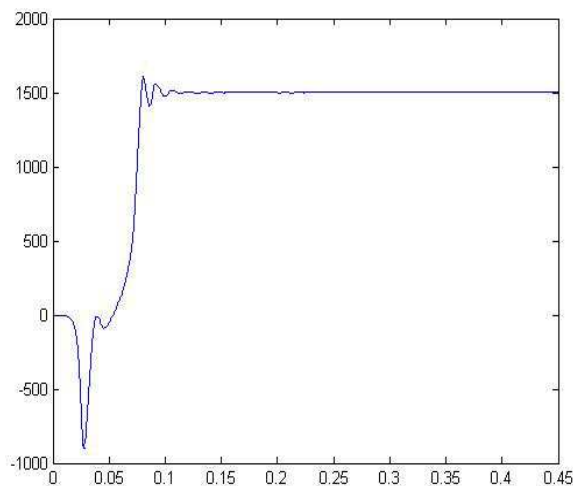

Fig.12. Rotor speed in rpm of PMSM drive

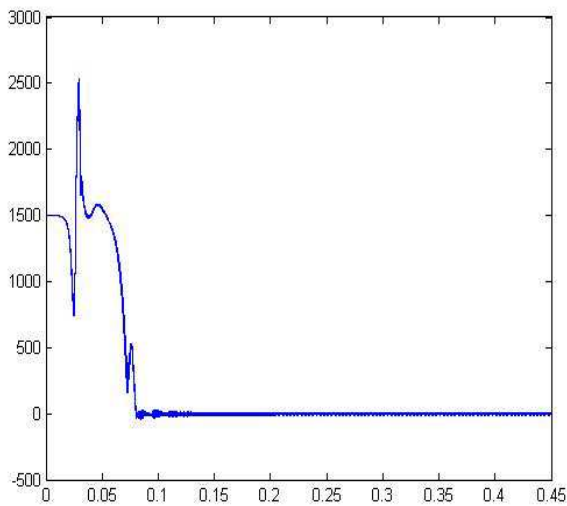

Fig.13. Speed error of PMSM drive

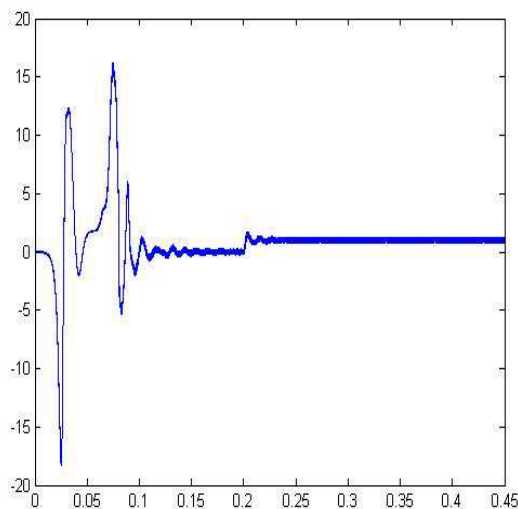

Fig.14. Electromagnetic torque of PMSM drive

VII. CONCLUSION

The whole drive system is simulated by the use of Matlab/Simulink. Starting with the motor equations, a model for the PMSM has been developed in Simulink, as well as models for the SVPWM signal generator, 2-level inverter, PI controller, Park transformations and MRAS. The results of the simulation show the good response of the model when tracking a command speed. The simulation results have proved that the proposed space vector pulse width modulation based control of a permanent magnet synchronous motor drive has a good performance for the torque, speed and position control of PMSM using MRAS. The results obtained shows that SVPWM control strategy based on MRAS approach can be applied successfully for PMSM drives with low cost.

REFERENCES

1. S. Ozçira, N. Bekiroglu, E. Ayçiçek "Speed control of permanent magnet synchronous motor based on direct torque control method", IEEE/ISPE, pp.268-272,2008.
2. A. H. Wijenayake and P. B. Schmidt, "Modeling and analysis of permanent magnet synchronous motor by taking saturation and core loss into account," International Conference on Power Electronics and Drive Systems, (Volume:2) 1997.

3. Sen, P. C. Electric motor drives and control-past, present, and future[J], IEEE Transactions on Industrial Electronics, 1990,37(1),562-575.
4. B. Cui, J. Zhou, and Z. Ren, "Modeling and simulation of permanent magnet synchronous motor drives," 2001.
5. Tzann-Shin Lee, Chih-Hong Lin, Faa-Jeng Lin. An adaptive H controller design for permanent magnet synchronous motor drives[J], Control Engineering Practice,2005,13 (4): 425-439
6. Z.Ibrahim, E.Levi; An experimental investigation of fuzzy logic speed control in permanent magnet synchronous motor drives, *European Power Electronics and Drives Journal*, vol. 12, no. 2, 2002, pp. 37-42.
7. PETROVIC, V.—ORTEGA, R.—STANKOVIC, A. M.—TADMOR, G. : Design and Implementation of an Adaptive Controller for Torque Ripple Minimization in PM Synchronous Motors, IEEE Trans. on Power Electronics 15 No. 5 (Sep 2000), 871-880.
8. KO, J.—YOUN, S.—KIM, Y.: : A Robust Adaptive Precision Position Control of PMSM, Industry Applications Conference, 37th IAS Annual Meeting, vol. 1, Pittsburgh, PA , USA, 2002, pp. 120-125.
9. LIU, T.-H.—PU, H.-T.—LIN, C.-K.: : Implementation of an Adaptive Position Control System of a Permanent-Magnet Synchronous Motor and its Application, IET Electr. Power Appl. 4 No. 2 (2010), 121-130.
10. Tian Ming-xiu, Wang Li-mei, Zhen Jian-feng. "Sensorless position control scheme for permanent magnet synchronous motor drive", School of Electrical Engineering, Shengyang University of Technology, 10, 27(5), 2005.
11. J. Luukko, "Direct Torque Control of Permanent Magnet Synchronous Machines-Analysis and Implementation", Diss. Lappeenranta University of Technology, Stockholm, Sweden, 2000.
12. S. Dan, F. Weizhong, H. Yikang, "Study on the direct torque control of permanent magnet synchronous motor drives". IEEE/ICEMS, Vol.1, pp.571 - 574, 2001.

Mr.P. Nagasekhar Reddy received his M.Tech degree from Jawaharlal Nehru technological University, Hyderabad, India in 2005. He is presently working as Sr. Assistant Professor, MGIT, Hyderabad. Also, he is pursuing his Ph.D from Jawaharlal Nehru technological University, Hyderabad, India. He published 20 research papers in various international journals and conferences. His research interests include PWM techniques and control of electrical drives.

