

A Flat Gain Low Noise Amplifier For 1.8 to 4 GHz Wide Band Wireless Receivers

M. Meloui, I. Akhchaf, H. Setti, M. Charif, and M. Essaïdi
Electronics and Microwave Group
Abdelmalek Essaadi University
Tetuan, Morocco

Abstract—This paper presents a design technique for a low-noise amplifier for the 1.8-4 GHz ultra wideband (UWB) wireless receivers. The LNA uses a circuit topology consisting of one gain stage with series inductor feedback using ATF technology and it is operated at 1 V. The noise figure of this LNA varies from 3 to 1.5 dB, and its gain is very flat 10 dB through out frequency band spanning from 1.8 to 4 GHz.

These results were obtained using Agilent ADS commercial simulator and confirmed with ansoft designer utilizing ATF-10136 amplifier technology.

Index Terms— ATF-technology, ultrawide band amplifier, series feedback amplifier, flat gain.

I. INTRODUCTION

The Federal Communications Commission approved the use of UWB technology for commercial applications in the unlicensed 3.1–10.6GHz frequency range. The UWB technologies an ideal candidate for many applications because it's based on the transmission and reception of trains of short pulses having very low power, can achieve very good time and spatial resolutions.

For this reason the use of the low noise amplifiers (LNAs) in UWB systems demand linear high gain and low Noise Figure operating at low DC bias conditions over a wide band to amplify the weak signal received by the antenna.

A low noise amplifier (LNA) is a first block in the receiver path of a wireless system, the primary objective of the LNA is to achieve large gain and low noise figure this objective should be achieved. At the input of the LNA a general impedance of 50 ohm is considered.

The series feedback topology (Figure 1) and Agilent Technologies are good candidates to reduce the noise figure and increases the maximum power gain available from an active device.

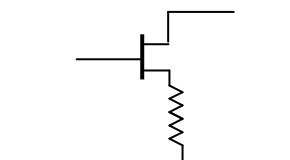

Figure 1 Series feedback

In order To meet these requirements, this paper reports a 1.8 - 4 GHz UWB two stages feedback LNA in GaAs MESFET ATF-10136 technology.

II. DESIGN FOR WIDE-BAND LNA FLAT GAIN

Flat gain, low noise figure over wide band (1.8GHz to 4 GHz) are met in these design, for all of these requirements, the proposed low noise one stage flat gain amplifier is illustrated in figures 2 and 3. The LNA consists of a good wideband matching network in the input and output of the stage, and the series feedback amplifiers using ATF technologies.

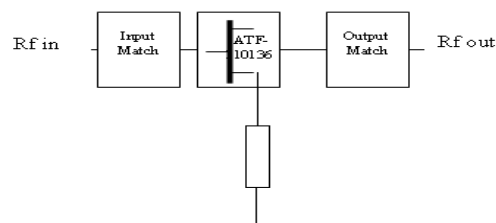

Figure 2 UWB LNA

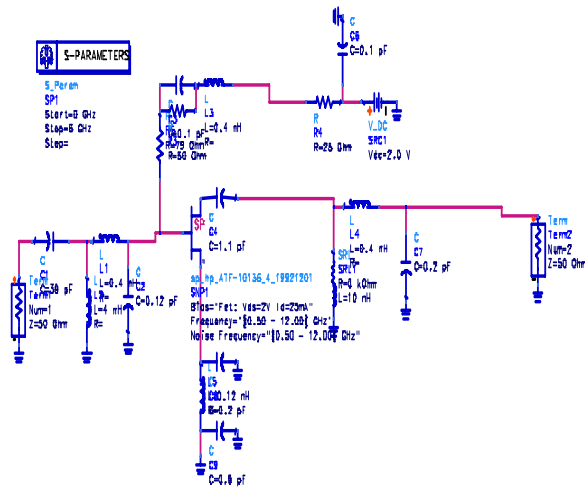

Figure 3 Schematic of the series UWB feedback LNA

In the general, the essential requirement to achieve maximum gain is a good matching network between the load and the source, in this design we utilize π -shaped LC-matching network[1], In order to get the desired wide-band frequency operating at 1.8 to 8 GHz and for the design flexibility [7]. The goal of the proposed LNA is to design an UWB receiver with a considerably low noise figure and flat gain as much as possible. These requirements can be met using a feedback topology. These techniques have been utilized in different designs in the past for amplifiers over an octave bandwidth, therefore the feedback technique seems to be the best solution because it has many advantages and it can be used in broadband amplifiers to control the gain flatness and to reduce the input and output VSWR at the same time and makes the circuit more robust. Among the other important advantages, the feedback controls the bandwidth extension of the amplifier [3]-[5]- [6] .

III. NUMERICAL RESULTS

The integrated flat gain LNA is implemented in a commercial GaAs MESFET ATF-10136 technology. This LNA was simulated using Agilent ADS commercial simulator and compared by another commercial simulator Ansoft Designer. Forward gain and input return loss of the amplifier are characterized in Figure 4 which shows the simulated S21 and S11, using these two simulators, at frequencies from 1.8 GHz to 4 GHz. The power gain is maximum and very flat around nominal 10 dB. The return loss is below -10 dB over the entire 1.8.- 4 GHz UWB frequency band. The noise figure

(NF) of the amplifier is shown in Fig. 5. This NF varies from 3 dB at 1.8 GHz and 1.5 dB at 4 GHz.

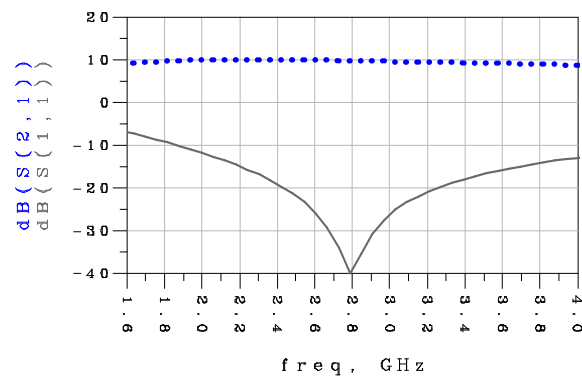

(a)

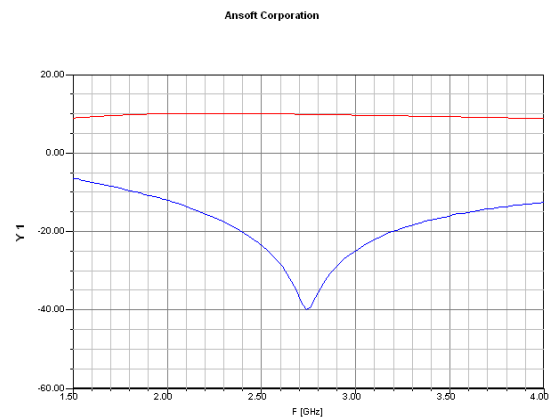

(b)

Figure 4 Simulated gain S21and input return loss S11 across UWB frequency band of the LNA using (a) ADS and (b) Ansoft Designer.

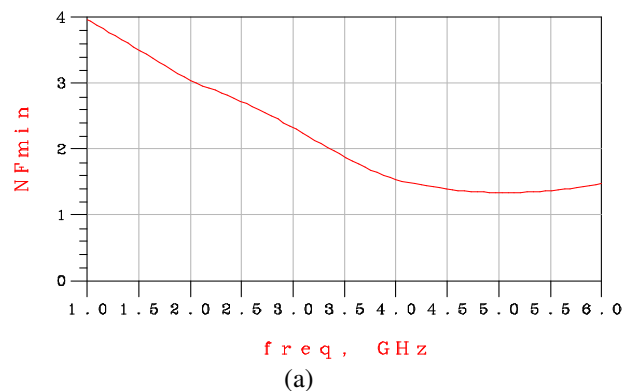

(a)

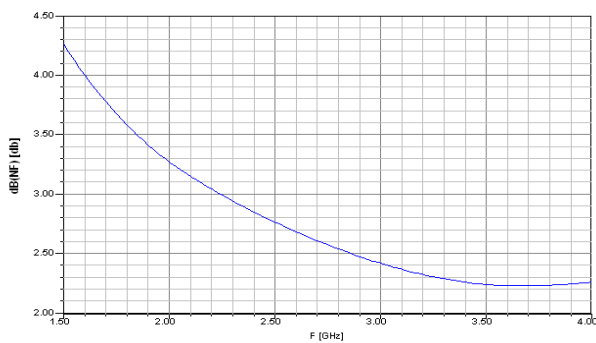

(b)

Figure 5 The simulated noise figure (NF) by (a) ADS and (b) ANSOFT Designer.

IV. CONCLUSION

In this paper, we present an ultra-wide band LNA from 1.8 GHz to 4 GHz in a commercial GaAs MOSFET ATF-10136, utilizing an improved series feedback topology based on a one stage amplifier and a π -shaped broadband LC-matching networks. The LNA has been simulated and compared by ADS and ANSOFT Designer simulators to achieve a noise figure lower than 3 dB at 1.8GHz and 1.5 dB at 4 GHz and a flat gain of 10dB in the 1.8~4 GHz frequency band.

REFERENCES

- [1] A. Bevilacqua and A. Niknejad, "An ultra-wideband CMOS LNA for 3.1 to 10.6 GHz wireless receivers," *IEEE J. Solid-State Circuits*, vol. 39, no. 12, pp. 2259–2268, Dec. 2004.
- [2] R. C. Liu, "Design and analysis of DC to 14 GHz and 22 GHz CMOS cascode distributed amplifier," *IEEE J. Solid-State Circuits*, vol. 39, no. 8, pp. 1370–1374, Aug. 2004.
- [3] C.-W. Kim, M.-S. Kang, P. T. Anh, H.-T. Kim, and S.-G. Lee, "An ultra-wideband CMOS low noise amplifier for 3–5-GHz UWB system," *IEEE J. Solid-State Circuits*, vol. 40, no. 2, pp. 544–547, Feb. 2005.
- [4] F. Zhang and P. Kinget, "Low power programmable-gain CMOS distributed LNA for ultra-wideband applications," in *IEEE Symp. VLSI Circuits Symp. Dig.*, Jun. 2005, pp. 78–81.
- [5] C.-P. Chang and H.-R. Chuang, "0.18 μ m 3–6 GHz CMOS broadband LNA for UWB radio," *Electron. Lett.*, vol. 41, no. 12, pp. 696–698, Jun. 2005.
- [6] Yueh-Hua Yu, Yi-Jan Emery Chen, "A 0.6-V Low Power UWB CMOS LNA," *IEEE Microwave And Wireless Components Letters*, Vol. 17, No. 3, March 2007
- [7] Y. Wei-ming; H. Li-ping; Y. Bin; X. Wan-bo; S. Chen; C. Jian-xin, "The Design of 3.6GHz 4.2GHz Low Noise Amplifier," in *IEEE Symp.* Aug. 2007, pp. 458 - 461
- [8] Yee, K. S. "Numerical solution of initial boundary value problems involving Maxwell's equations in isotropic media", *IEEE Trans. Antennas and Propagation*, Vol. 14, 302-307, May 1966.

[9] A. Taflove and S. Hagness, *Computational Electrodynamics: The Finite-Difference Time-Domain Method*, 3rd ed. Boston, MA: Artech House, 2500.